

## T322E226K035AS7200

Aliases (T322E226K035AS7443, T322E226K035ASTR)

T322, Tantalum, MnO2 Tantalum, Commercial Grade, 22 uF, 10%, 35 VDC, 1.3 Ohms

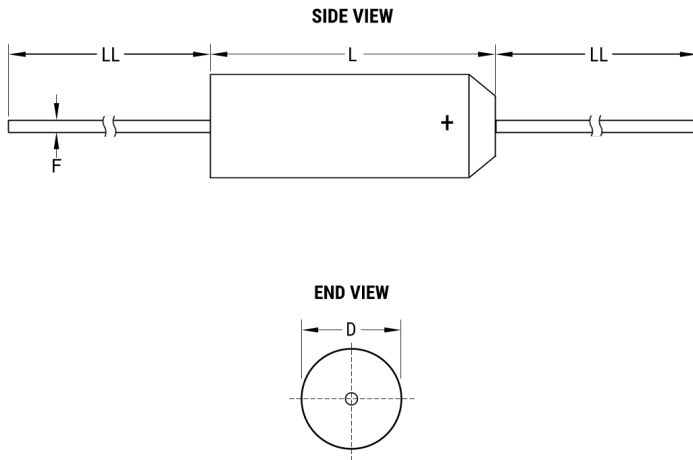

Click [here](#) for the 3D model.

Dimensions	
D	7.11mm MAX
L	13.46mm MAX
LL	25.4mm MIN
F	0.64mm +/-0.05mm

Packaging Specifications	
Packaging	T&R, 305mm, Class I, B = 52.4mm
Packaging Quantity	500

General Information	
Series	T322
Dielectric	MnO2 Tantalum
Style	Axial
Description	Axial, Solid Tantalum, Molded, Military (Non-ER), Low ESR
Features	Low ESR
RoHS	No
Prop 65	<b>⚠ WARNING:</b> Cancer and reproductive harm - <a href="http://www.p65warnings.ca.gov">http://www.p65warnings.ca.gov</a> .
SCIP Number	1f352243-82e7-4839-9036-6c061d7f7da2
Termination	Lead (SnPb)
Lead	Wire Leads
AEC-Q200	No
Notes	Uninsulated.
Shelf Life	156 Weeks

Specifications	
Capacitance	22 uF
Capacitance Tolerance	10%
Voltage DC	35 VDC (85C), 23.35 VDC (125C Surge), 0.35 VDC (125C Reverse)
Temperature Range	-55/+125°C
Rated Temperature	85°C
Dissipation Factor	6%
Resistance	1.3 Ohms (100kHz)
Leakage Current	6.2 uA (25°C)

Statements of suitability for certain applications are based on our knowledge of typical operating conditions for such applications, but are not intended to constitute - and we specifically disclaim - any warranty concerning suitability for a specific customer application or use. This Information is intended for use only by customers who have the requisite experience and capability to determine the correct products for their application. Any technical advice inferred from this Information or otherwise provided by us with reference to the use of our products is given gratis, and we assume no obligation or liability for the advice given or results obtained.