

L0806BR47JSWST

Aliases (L0806BR47JSWST)

Obsolete

KEMET, L-SWS, Ferrite, 5%, 470 nH, 0806

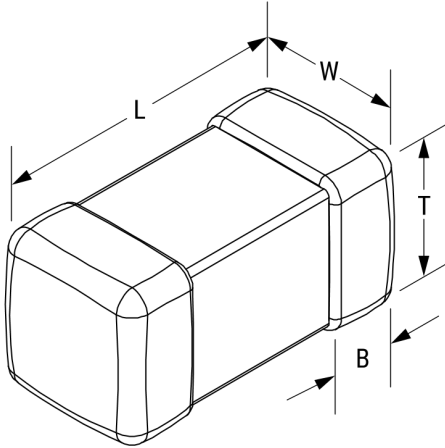

Click [here](#) for the 3D model.

General Information

Series	L-SWS
Style	SMD Wire-Wound
Core	Ferrite
RoHS	Yes
Notes	Last Order Date June 30, 2023.

Specifications

Inductance	470 nH
Inductance Tolerance	5%
Temperature Range	-40/+105°C
Current	430 mAmps (MAX)
DC Resistance	0.26 Ohms
Self-Resonant Frequency	350 MHz MIN

Dimensions

Chip Size	0806
L	2mm +/-0.2mm
W	1.6mm +/-0.2mm
T	1.6mm +/-0.2mm

Packaging Specifications

Packaging	T&R
Packaging Quantity	2000

Statements of suitability for certain applications are based on our knowledge of typical operating conditions for such applications, but are not intended to constitute - and we specifically disclaim - any warranty concerning suitability for a specific customer application or use. This Information is intended for use only by customers who have the requisite experience and capability to determine the correct products for their application. Any technical advice inferred from this Information or otherwise provided by us with reference to the use of our products is given gratis, and we assume no obligation or liability for the advice given or results obtained.