

Overview

The KEMET TPI ferrite core inductors are designed for a very low core loss. Its flat wire, “one turn through the construction” design, enables high efficiency at large currents. The core material is ideal for high switching frequency applications.

The TPI series offers two solutions. One set of parts are DC optimized inductors for hard SW topology, 12 V power distribution. The other set comprises AC optimized inductors for soft SW topology, 48 V power distribution. These AC optimized inductors were developed for STC (Switched Tank Convertor) technology.

Applications

- Hard-switching topology for DC/DC conversion
- Soft-switching topology for AC resonant conversion
- Point of loads (POL)
- Servers and storage
- Supercomputers
- Various decentralized power supplies

Benefits

- One turn coil ferrite
- Operating temperature up to +125°C
- High switching frequency
- Low core loss
- Low DCR
- High current
- Low self-heating
- AC optimized inductor reduce close to 50% the total loss compared to conventional inductor due to optimized structure and material designed for STC technology



Part Number System

TPI	128080	L	180	N
Series	Size Code	Inductor	Inductance Code nH	Version
TPI	076790 077050 078060 111065 118082 128080 9664A0 * A = 10		xxx = xxx nH	N = Standard R = Low DC resistance

Performance Characteristics

Item	Performance Characteristics
Operating Temperature	-40°C to +125°C (including self-temperature rise)
Rated Inductance Range	47 – 230 nH at 100 kHz, 1 mA
Inductance Tolerance	±10% (except ±20% for TPI077050L105N)
Rated DC Resistance	0.145 – 0.62 mΩ
DC Resistance Tolerance	±5% (except ±9.5% for TPI077050L105N and ±10.0% for TPI078060L***N)
Rated Current	29 – 66 A

Table 1 – Ratings & Part Number Reference – DC Optimized TPI Inductors

Part Number	Inductance (nH) at 100 kHz, 1 mA	Inductance Tolerance	DC Resistance (mΩ)	Rated Current (A)			Weight (g)	
				Irms ¹ (Ref.)	Isat ² (Ref.)			
					25°C	85°C		125°C
TPI076790L150N	150	±10%	0.62 ±5.0%	29	60	51	44	1.8
TPI077050L105N	105	±20%	0.32 ±9.5%	36	60	51	44	1.0
TPI118082L150N	150	±10%	0.29 ±5.0%	50	93	79	67	3.0
TPI118082L180N	180	±10%	0.29 ±5.0%	50	79	67	57	3.0
TPI111065L210N	210	±10%	0.29 ±5.0%	50	54	46	38	3.1
TPI128080L180N	180	±10%	0.29 ±5.0%	50	78	68	54	3.5
TPI128080L210N	210	±10%	0.29 ±5.0%	50	70	60	52	3.5
TPI128080L230N	230	±10%	0.29 ±5.0%	50	64	56	50	3.5
TPI9664A0L090N	90	±10%	0.185 ±5.0%	58	115	105	90	2.7
TPI9664A0L110N	110	±10%	0.185 ±5.0%	58	104	91	78	2.7
TPI9664A0L120N	120	±10%	0.185 ±5.0%	58	99	84	72	2.7
TPI9664A0L150R	150	±10%	0.145 ±5.0%	66	71	61	57	2.7

¹ T = 40 K rise at rated current

² Inductance drop 20% at rated current

All electrical characteristics data is referenced to 25°C.

Table 2 – Ratings & Part Number Reference – AC Optimized TPI Inductors

Part Number	Inductance (nH) at 100 kHz, 1 mA	Inductance Tolerance	DC Resistance (mΩ)	Rated Current (A)			Weight (g)	
				Irms ¹ (Ref.)	Isat ² (Ref.)			
					25°C	85°C		125°C
TPI078060L047N	47	±10%	0.31 ±10.0%	53	90	75	67	1.2
TPI078060L056N	56	±10%	0.31 ±10.0%	53	81	67	58	1.2
TPI078060L068N	68	±10%	0.31 ±10.0%	53	69	58	50	1.2
TPI078060L082N	82	±10%	0.31 ±10.0%	53	54	46	40	1.2

¹ T = 40 K rise at rated current

² Inductance drop 20% at rated current

All electrical characteristics data is referenced to 25°C.

DC-Superposed Characteristics

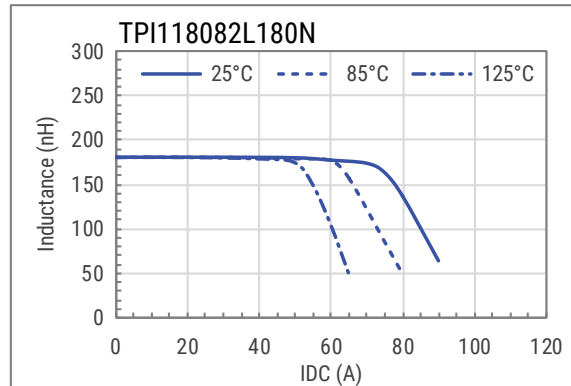
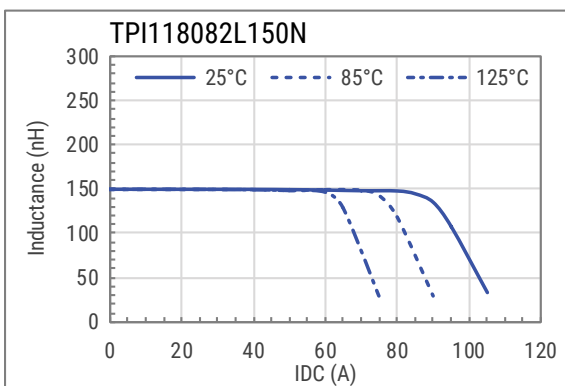
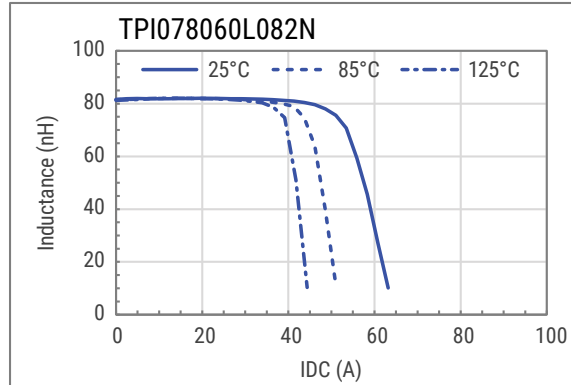
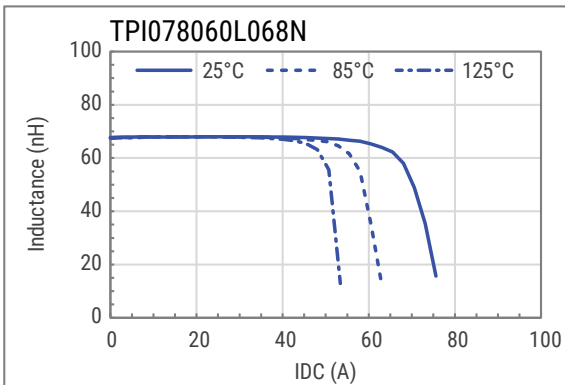
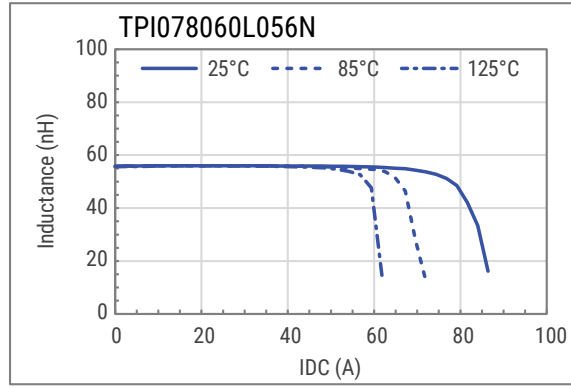
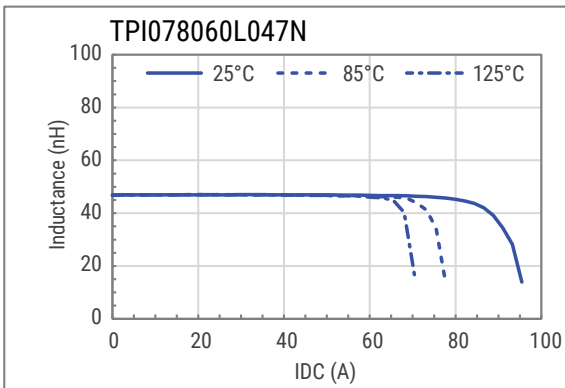
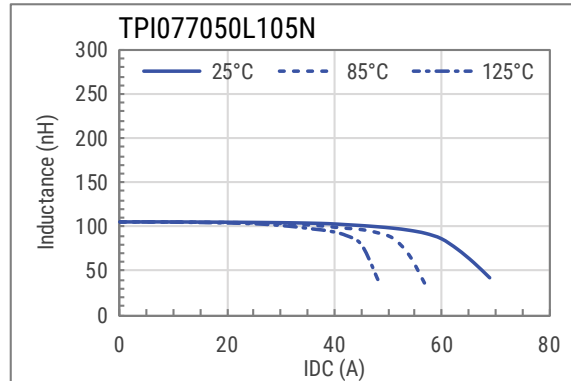
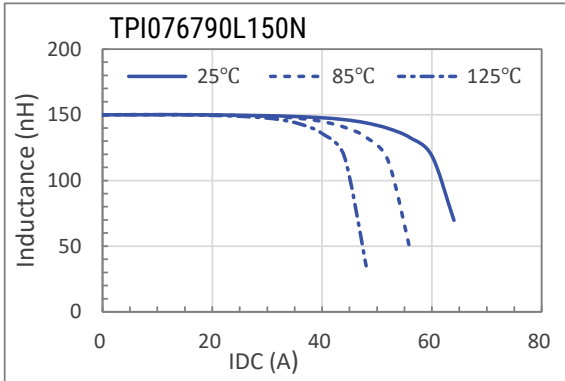

DC-Superposed Characteristics cont.

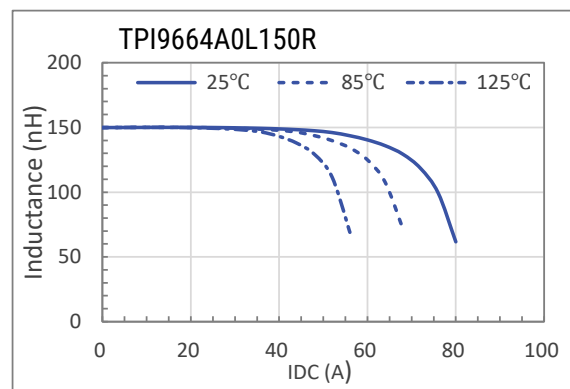
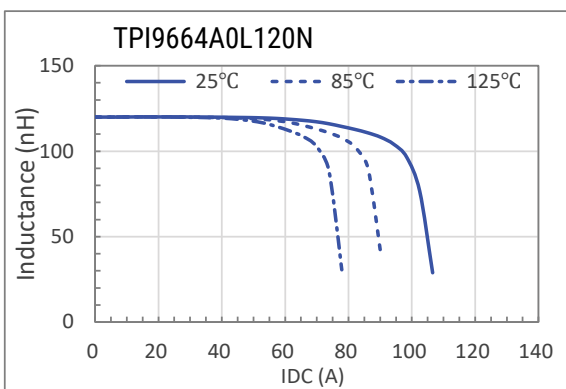
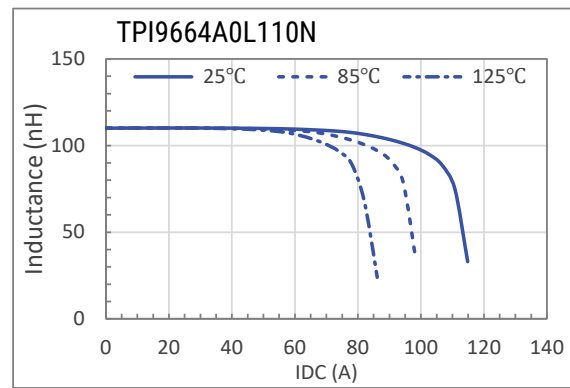
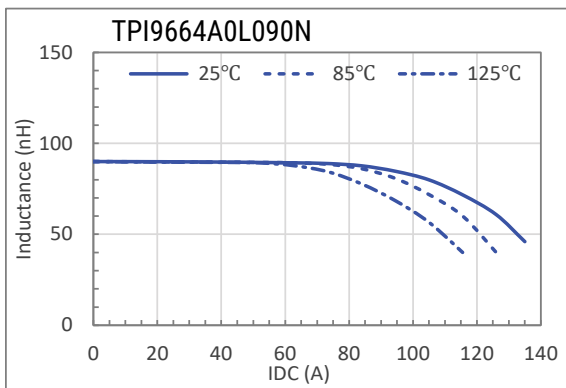
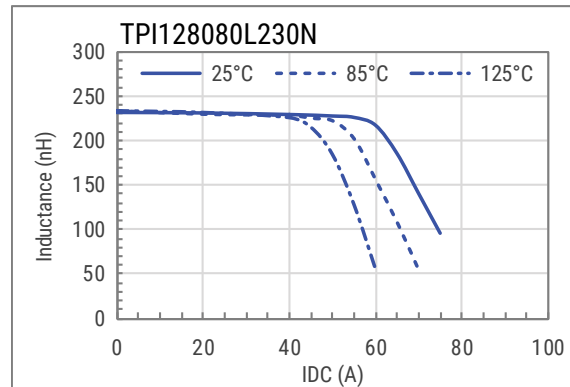
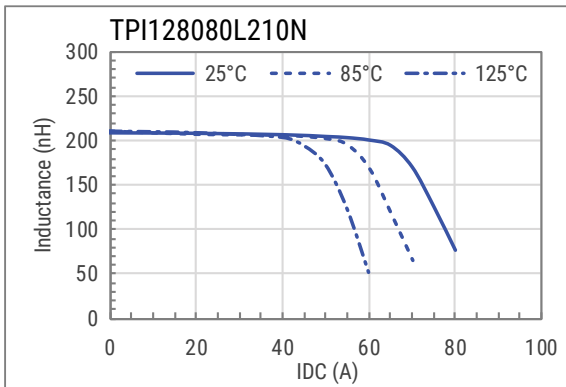
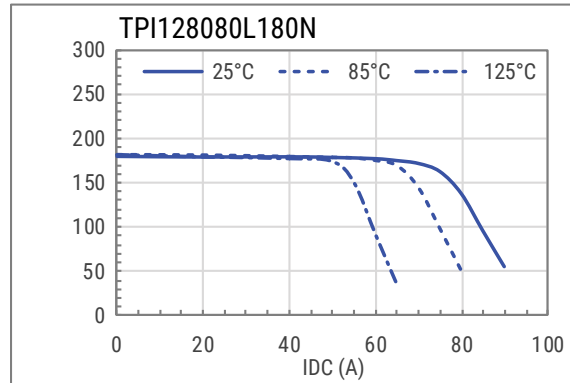
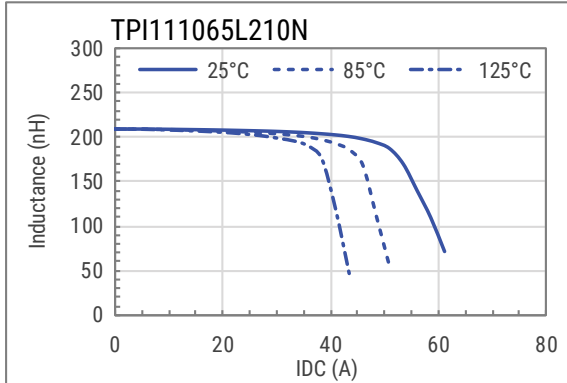

Dimensions

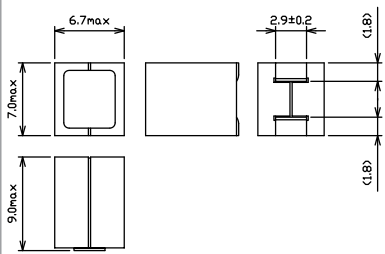
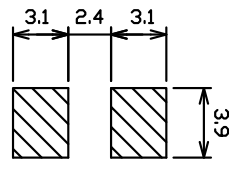
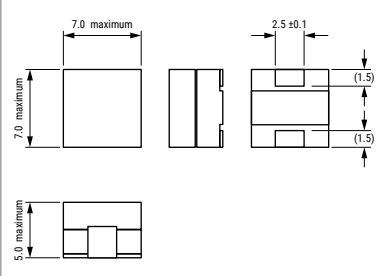
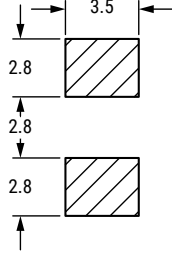
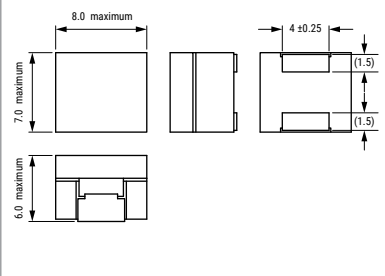
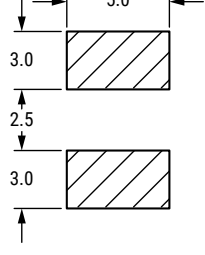
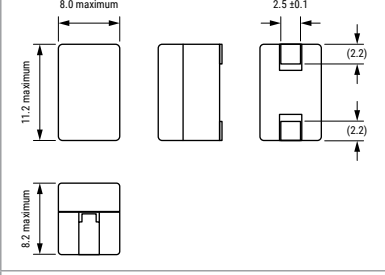
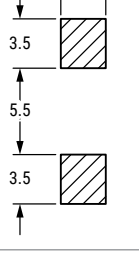
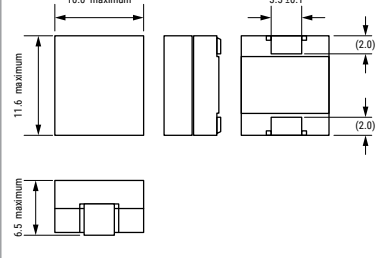
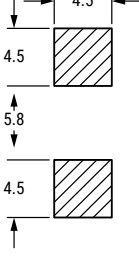
Case Size	Dimensions (mm)	Land Pattern (mm)
TPI076790		
TPI077050		
TPI078060		
TPI118082		
TPI111065		

Dimensions cont.

Case Size	Dimensions (mm)	Land Pattern (mm)
TPI128080		
TPI9664A0		
Exception TPI9664A0L150R		

Taping Specification

Dimensions of Indented Square Hole Plastic Tape

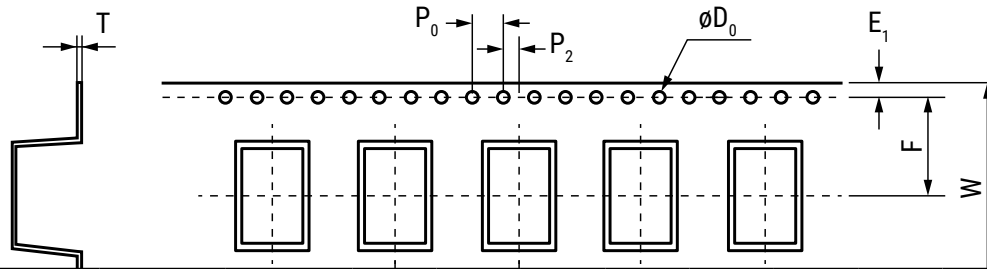

Case Size	Reel Quantity		Dimensions (mm)								
			W	F	E ₁	P ₁	P ₂	P ₀	øD ₀	T	
TPI076790	300	Tolerance	±0.30	±0.10	±0.10	±0.10	±0.10	±0.10	±0.10	±0.05	±0.05
		Nominal	24.00	11.50	1.75	16.00	2.00	4.00	1.55	0.40	
TPI077050	1,000	Tolerance	±0.30	±0.10	±0.10	±0.10	±0.10	±0.10	±0.10	±0.05	±0.05
		Nominal	16.00	7.50	1.75	12.00	2.00	4.00	1.55	0.40	
TPI078060	1,000	Tolerance	±0.30	±0.10	±0.10	±0.10	±0.10	±0.10	±0.10	±0.05	±0.05
		Nominal	16.00	7.50	1.75	12.00	2.00	4.00	1.55	0.40	
TPI118082	400	Tolerance	±0.30	±0.10	±0.10	±0.10	±0.10	±0.10	±0.10	±0.05	±0.05
		Nominal	24.00	11.50	1.75	16.00	2.00	4.00	1.55	0.40	
TPI111065	500	Tolerance	±0.30	±0.10	±0.10	±0.10	±0.10	±0.10	±0.10	±0.05	±0.05
		Nominal	24.00	11.50	1.75	16.00	2.00	4.00	1.55	0.40	
TPI128080	400	Tolerance	±0.30	±0.10	±0.10	±0.10	±0.10	±0.10	±0.10	±0.05	±0.05
		Nominal	24.00	11.50	1.75	16.00	2.00	4.00	1.55	0.40	
TPI9664A0	500	Tolerance	±0.30	±0.10	±0.10	±0.10	±0.10	±0.10	±0.10	±0.05	±0.05
		Nominal	24.00	11.50	1.75	16.00	2.00	4.00	1.55	0.40	

Reel Specifications

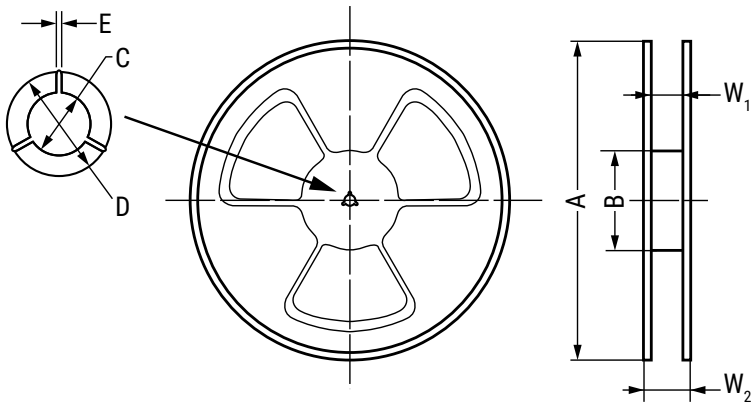

Case Size		Dimensions (mm)						
		A	B	C	D	E	W ₁	W ₂
TPI076790	Tolerance	±2.0	±1.0	±0.2	±0.2	±0.3		
	Nominal	ø330	ø100	ø13.2	ø21.5	2.0	24.5	28.9
TPI077050	Tolerance	±2.0	±1.0	±0.2	±0.2	±0.3		
	Nominal	ø330	ø100	ø13.2	ø21.5	2.0	16.5	20.9
TPI078060	Tolerance	±2.0	±1.0	±0.2	±0.2	±0.3		
	Nominal	ø380	ø80	ø13.0	ø21.0	2.3	17.5	21.5
TPI118082	Tolerance	±2.0	±1.0	±0.2	±0.2	±0.3		
	Nominal	ø330	ø100	ø13.2	ø21.5	2.3	24.5	28.9
TPI111065	Tolerance	±2.0	±1.0	±0.2	±0.2	±0.3		
	Nominal	ø330	ø100	ø13.2	ø21.5	2.0	24.5	28.9
TPI128080	Tolerance	±2.0	±1.0	±0.2	±0.2	±0.3		
	Nominal	ø330	ø100	ø13.2	ø21.5	2.0	24.5	28.9
TPI9664A0	Tolerance	±2.0	±1.0	±0.2	±0.2	±0.3		
	Nominal	ø330	ø100	ø13.2	ø21.5	2.0	24.5	28.9

Soldering Process

Recommended Reflow Soldering Profile

Reference ICP/JEDEC J-STD-020E

Profile Feature	Pb-Free Assembly
Preheat/Soak	
Temperature minimum (T_{smin})	150°C
Temperature maximum (T_{smax})	200°C
Time (t_s) from T_{smin} to T_{smax}	60 – 120 seconds
Ramp-up rate (T_L to T_p)	3°C/second maximum
Liquidous Temperature (T_L)	217°C
Time Above Liquidous (t_L)	60 – 150 seconds
Peak Temperature (T_p)	245°C for TPI076790, 118082, 111065, 128080, 9664A0 250°C for TPI077050, 078060
Time within 5°C of Maximum Peak temperature (t_p)	30 seconds maximum
Ramp-down Rate (T_p to T_L)	6°C/second maximum
Time 25°C to Peak Temperature	8 minutes maximum

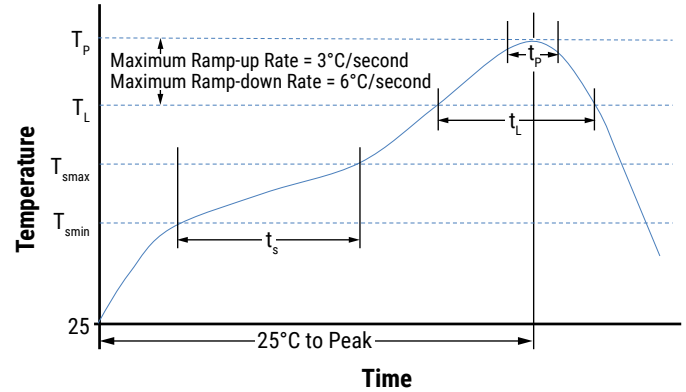

Environmental Compliance

All KEMET SMD Inductors are RoHS compliant.



Handling Precautions

Inductors should be stored in normal working environments. While the inductors themselves are quite robust in other environments, solderability will be degraded by exposure to high temperatures, high humidity, corrosive atmospheres, and long term storage.

KEMET recommends that maximum storage temperature not exceed 40°C and maximum storage humidity not exceed 70% relative humidity. Atmospheres should be free of chlorine and sulfur bearing compounds. Temperature fluctuations should be minimized to avoid condensation on the parts.

For optimized solderability, inductors' stock should be used promptly, preferably within six months of receipt.

KEMET Electronics Corporation Sales Offices

For a complete list of our global sales offices, please visit www.kemet.com/sales.

Disclaimer

YAGEO Corporation and its affiliates do not recommend the use of commercial or automotive grade products for high reliability applications or manned space flight.

All product specifications, statements, information and data (collectively, the "Information") in this datasheet are subject to change. The customer is responsible for checking and verifying the extent to which the Information contained in this publication is applicable to an order at the time the order is placed. All Information given herein is believed to be accurate and reliable, but it is presented without guarantee, warranty, or responsibility of any kind, expressed or implied.

Statements of suitability for certain applications are based on KEMET Electronics Corporation's ("KEMET") knowledge of typical operating conditions for such applications, but are not intended to constitute – and KEMET specifically disclaims – any warranty concerning suitability for a specific customer application or use. The Information is intended for use only by customers who have the requisite experience and capability to determine the correct products for their application. Any technical advice inferred from this Information or otherwise provided by KEMET with reference to the use of KEMET's products is given gratis, and KEMET assumes no obligation or liability for the advice given or results obtained.

Although KEMET designs and manufactures its products to the most stringent quality and safety standards, given the current state of the art, isolated component failures may still occur. Accordingly, customer applications which require a high degree of reliability or safety should employ suitable designs or other safeguards (such as installation of protective circuitry or redundancies) in order to ensure that the failure of an electrical component does not result in a risk of personal injury or property damage.

Although all product-related warnings, cautions and notes must be observed, the customer should not assume that all safety measures are indicated or that other measures may not be required.

When providing KEMET products and technologies contained herein to other countries, the customer must abide by the procedures and provisions stipulated in all applicable export laws and regulations, including without limitation the International Traffic in Arms Regulations (ITAR), the US Export Administration Regulations (EAR) and the Japan Foreign Exchange and Foreign Trade Act.

KEMET is a registered trademark of KEMET Electronics Corporation.