

# T111 Axial MIL-PRF-39003 Non-Polar and T213 (CSR91 Style)

## Overview

The T111/T213 Series is primarily designed for use in tuned low frequency circuits, phasing low voltage AC motors, servo systems and other applications where reversal of polarity is a primary consideration. The T111 unit consists of two polar T110 Series hermetically sealed tantalum capacitors, electrically and mechanically connected back-to-back and supported by an outer corrosion-resistant

metal sleeve. They exhibit comparable electrical and performance characteristics of T110 Series. Available in capacitance values from 0.0023  $\mu\text{F}$  to 160  $\mu\text{F}$  in  $\pm 20\%$  and  $\pm 10\%$  tolerances, the T111 series is offered in working voltages of 6 VDC to 100 VDC at  $+85^\circ\text{C}$ .

## Benefits

- Taped and reeled per EIA Specification RS-296
- Marking per MIL-STD-1285
- Qualified to MIL-PRF-39003 (CSR91 Style)
- Failure rate options: Graded – B, C, D, and G Exponential – M, P, R, and S\*
- Capacitance values of 0.0023  $\mu\text{F}$  to 160  $\mu\text{F}$
- Tolerances of  $\pm 5\%$ ,  $\pm 10\%$  and  $\pm 20\%$
- Voltage rating of 6 – 100 VDC
- Operating temperature range of  $-55^\circ\text{C}$  to  $+125^\circ\text{C}$
- Case sizes: A, B, C, D

*\*Failure rates apply to military products only*



## Applications

Typical applications include use in tuned low frequency circuits, phasing low voltage AC motors, servo systems and other applications where reversal of polarity is a primary consideration.

## Ordering Information – T111

T	111	A	105	K	050	A	S	
Capacitor Class	Series	Case Size	Capacitance Code (pF)	Capacitance Tolerance	Rated Voltage (VDC)	Failure Rate/Military Product Only	Termination Finish	Specification
T = Tantalum	Hermetically sealed axial capacitor	A B C D	First two digits represent significant figures. Third digit specifies number of zeros.	J = ±5% K = ±10% M = ±20%	006 = 6 010 = 10 015 = 15 020 = 20 035 = 35 050 = 50 075 = 75 100 = 100	A = N/A	S = Standard (Sn/Pb)	All capacitors are sleeved unless specified.

## Ordering Information – T213 (CSR91 Style)

MIL product

T	213	A	115	K	020	B	S	7200
Capacitor Class	Series	Case Size	Capacitance Code (pF)	Capacitance Tolerance	Rated Voltage (VDC)	Failure Rate/Military Product Only	Termination Finish	Specification
T = Tantalum	Hermetically sealed axial military grade capacitor	A B C D	First two digits represent significant figures. Third digit specifies number of zeros.	K = ±10% M = ±20%	006 = 6 010 = 10 015 = 15 020 = 20 035 = 35 050 = 50 075 = 75 100 = 100	Graded: B = 0.1%/k hours C = 0.01%/k hours D = 0.001%/k hours G = 1.0 %/k hours Exponential: M = 1%/k hours P = 0.1%/k hours R = 0.01%/k hours S = 0.001%/k hours	S = Standard (Sn/Pb)	Blank = Sleeved/Bulk 0100 = Without sleeve 7200 = Tape & Reel 7293 & 7443 = Ammo 4250 = "A" surge current 4251 = "B" surge current 4252 = "C" surge current All capacitors are sleeved unless specified.

## Ordering Information – MIL-PRF-39003

M39003	/04	3007	A
Capacitor Class	Slash	Dash Number	Surge Option
Military specification number	Specification sheet number	Failure rate level	A = C-4250 B = C-4251 C = C-4252 Blank = No surge

Orders should be entered by the military specification number, including the dash number and surge option letter (A, B or C).

## Performance Characteristics

Item	Performance Characteristics
Operating Temperature	-55°C to 125°C
Rated Capacitance Range	0.0023 µF – 160 µF at 120 Hz/25°C
Capacitance Tolerance	J Tolerance (5%), K Tolerance (10%), M Tolerance (20%)
Rated Voltage Range	6 V – 100 V
DF (120 Hz at 25°C)	Refer to Part Number Electrical Specification Table
ESR and Impedance (100 kHz at 25°C)	Refer to Part Number Electrical Specification Table (for reference only)
Leakage Current	Refer to Part Number Electrical Specification Table (at rated voltage up to +85°C and 2/3 of rated voltage applied at 125°C)
Failure Rate (MIL-39003, CSR91 capacitors only)	Approved failure rate: S (0.001%/k hours) – Exponential, D (0.001%/k hours) – Graded

## Dimensions – Inches (Millimeters)

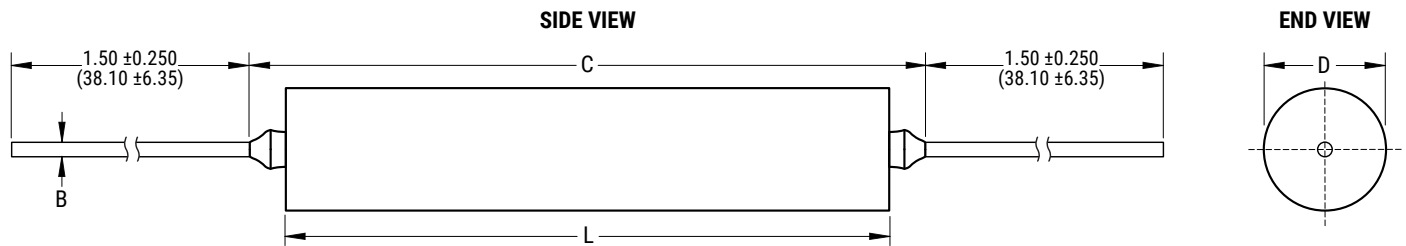

Case Size	Uninsulated		Insulated		B ±0.002 (±0.05)	C Maximum
	D ±0.005 (±0.13)	L ±0.031 (±0.79)	D ±0.010 (±0.25)	L ±0.031 (±0.79)		
A	0.147 (3.73)	0.565 (14.35)	0.161 (4.09)	0.575 (14.61)	0.020 (0.51)	0.750 (19.05)
B	0.194 (4.93)	0.916 (23.27)	0.207 (5.26)	0.955 (24.26)	0.020 (0.51)	1.130 (28.70)
C	0.300 (7.62)	1.340 (34.04)	0.314 (7.98)	1.350 (34.29)	0.025 (0.64)	1.525 (38.74)
D	0.362 (9.19)	1.540 (39.12)	0.376 (9.55)	1.550 (39.37)	0.025 (0.64)	1.725 (43.82)

**Table 1 – Ratings & Part Number Reference**

Rated Voltage	Rated Cap	Case Size Code	KEMET Part Number	DC Leakage	DF % at 25°C	MIL-PRF-39003 (CSR91) Capacitors										KEMET Equivalent Military
						Dash Number Reference								Part Number		
						Failure Rate Level (%/1,000 hours)										
						MIL-PRF-39003/4C				MIL-PRF-39003/4C						
						Exponential				Graded						
(V) 85°C	µF		(See below for part options)	µA at 25°C Max/5 Minutes	120 Hz Maximum	M (1.0)	P (0.1)	R (0.01)	S (0.001)	G (1.0)	B (0.1)	C (0.01)	D (0.001)			
6	2.8	A	T111A285K006AS	0.3	4	0221	0441	0661	0881	6001	3001	4001	5001	T213A285K006(1)S		
6	3.4	A	T111A345K006AS	0.3	6	0222	0442	0662	0882	6002	3002	4002	5002	T213A345K006(1)S		
6	3.4	A	T111A345M006AS	0.3	6	0223	0443	0663	0883	6003	3003	4003	5003	T213A345M006(1)S		
6	23.0	B	T111B236K006AS	1.5	6	0224	0444	0664	0884	6004	3004	4004	5004	T213B236K006(1)S		
6	23.0	B	T111B236M006AS	1.5	6	0225	0445	0665	0885	6005	3005	4005	5005	T213B236M006(1)S		
6	28.0	B	T111B286K006AS	1.5	6	0226	0446	0666	0886	6006	3006	4006	5006	T213B286K006(1)S		
6	75.0	C	T111C756K006AS	4.5	6	0227	0447	0667	0887	6007	3007	4007	5007	T213C756K006(1)S		
6	75.0	C	T111C756M006AS	4.5	6	0228	0448	0668	0888	6008	3008	4008	5008	T213C756M006(1)S		
6	90.0	C	T111C906K006AS	4.5	6	0229	0449	0669	0889	6009	3009	4009	5009	T213C906K006(1)S		
6	90.0	C	T111C906M006AS	5.5	6	0230	0450	0670	0890					T213C906M006(1)S		
6	130.0	D	T111D137K006AS	6.0	8	0231	0451	0671	0891	6010	3010	4010	5010	T213D137K006(1)S		
6	130.0	D	T111D137M006AS	6.0	8	0232	0452	0672	0892					T213D137M006(1)S		
6	160.0	D	T111D167K006AS	7.5	8	0233	0453	0673	0893	6011	3011	4011	5011	T213D167K006(1)S		
6	160.0	D	T111D167M006AS	7.5	8	0234	0454	0674	0894	6012	3012	4012	5012	T213D167M006(1)S		
10	1.9	A	T111A195K010AS	0.3	4	0235	0455	0675	0895	6013	3013	4013	5013	T213A195K010(1)S		
10	2.3	A	T111A235K010AS	0.4	4	0236	0456	0676	0896	6014	3014	4014	5014	T213A235K010(1)S		
10	2.3	A	T111A235M010AS	0.4	4	0237	0457	0677	0897	6015	3015	4015	5015	T213A235M010(1)S		
10	13.0	B	T111B136K010AS	2.0	6	0238	0458	0678	0898	6016	3016	4016	5016	T213B136K010(1)S		
10	16.0	B	T111B166K010AS	2.0	6	0239	0459	0679	0899	6017	3017	4017	5017	T213B166K010(1)S		
10	16.0	B	T111B166M010AS	2.0	6	0240	0460	0680	0900	6018	3018	4018	5018	T213B166M010(1)S		
10	19.0	B	T111B196K010AS	2.0	6	0241	0461	0681	0901	6019	3019	4019	5019	T213B196K010(1)S		
10	41.0	C	T111C416K010AS	3.0	6	0242	0462	0682	0902	6020	3020	4020	5020	T213C416K010(1)S		
10	50.0	C	T111C506K010AS	5.0	6	0243	0463	0683	0903	6021	3021	4021	5021	T213C506K010(1)S		
10	50.0	C	T111C506M010AS	5.0	6	0244	0464	0684	0904	6022	3022	4022	5022	T213C506M010(1)S		
10	60.0	C	T111C606K010AS	6.0	6	0245	0465	0685	0905	6023	3023	4023	5023	T213C606K010(1)S		
10	60.0	C	T111C606M010AS	6.0	6	0246	0466	0686	0906					T213C606M010(1)S		
10	90.0	D	T111D906K010AS	9.0	6	0247	0467	0687	0907	6024	3024	4024	5024	T213D906K010(1)S		
10	110.0	D	T111D117K010AS	10.0	8	0248	0468	0688	0908	6025	3025	4025	5025	T213D117K010(1)S		
10	100.0	D	T111D117M010AS	10.0	8	0249	0469	0689	0909	6026	3026	4026	5026	T213D117M010(1)S		
15	1.3	A	T111A135K015AS	0.3	4	0250	0470	0690	0910	6027	3027	4027	5027	T213A135K015(1)S		
15	1.6	A	T111A165K015AS	0.4	4	0251	0471	0691	0911	6028	3028	4028	5028	T213A165K015(1)S		
15	1.6	A	T111A165M015AS	0.4	4	0252	0472	0692	0912	6029	3029	4029	5029	T213A165M015(1)S		
15	9.0	B	T111B905K015AS	2.0	6	0253	0473	0693	0913	6030	3030	4030	5030	T213B905K015(1)S		
15	10.0	B	T111B106K015AS	1.5	6											
15	11.0	B	T111B116K015AS	2.0	6	0254	0474	0694	0914	6031	3031	4031	5031	T213B116K015(1)S		
15	11.0	B	T111B116M015AS	2.0	6	0255	0475	0695	0915	6032	3032	4032	5032	T213B116M015(1)S		
15	28.0	C	T111C286K015AS	4.0	6	0256	0476	0696	0916	6033	3033	4033	5033	T213C286K015(1)S		
15	34.0	C	T111C346K015AS	5.0	6	0257	0477	0697	0917	6034	3034	4034	5034	T213C346K015(1)S		
15	34.0	C	T111C346M015AS	5.0	6	0258	0478	0698	0918	6035	3035	4035	5035	T213C346M015(1)S		
15	60.0	D	T111D606K015AS	6.0	6	0259	0479	0699	0919	6036	3036	4036	5036	T213D606K015(1)S		
15	75.0	D	T111D756K015AS	10.0	6	0260	0480	0700	0920	6037	3037	4037	5037	T213D756K015(1)S		
15	75.0	D	T111D756M015AS	10.0	6	0261	0481	0701	0921	6038	3038	4038	5038	T213D756M015(1)S		
20	0.6	A	T111A604K020AS	0.3	4	0262	0482	0702	0922	6039	3039	4039	5039	T213A604K020(1)S		
20	0.75	A	T111A754K020AS	0.3	4	0263	0483	0703	0923	6040	3040	4040	5040	T213A754K020(1)S		
20	0.75	A	T111A754M020AS	0.3	4	0264	0484	0704	0924	6041	3041	4041	5041	T213A754M020(1)S		
(V) 85°C	µF	Case Size Code	(see below for part options)	µA at 25°C Max/5 Minimum	120 Hz Maximum	M (1.0)	P (0.1)	R (0.01)	S (0.001)	G (1.0)	B (0.1)	C (0.01)	D (0.001)	Part Number		
Rated Voltage	Rated Cap	Case Size Code	KEMET Part Number	DC Leakage	DF % at 25°C	MIL-PRF-39003 (CSR13) Capacitors										

(1) To complete KEMET part number, insert failure rate code from Ordering Information table.

**Table 1 – Ratings & Part Number Reference cont.**

Rated Voltage	Rated Cap	Case Size Code	KEMET Part Number	DC Leakage	DF % at 25°C	MIL-PRF-39003 (CSR91) Capacitors										KEMET Equivalent Military
						Dash Number Reference										
						Failure Rate Level (%/1,000 hours)										
						MIL-PRF-39003/4C					MIL-PRF-39003/4C					
						Exponential					Graded					
(V) 85°C	µF		(See below for part options)	µA at 25°C Max/5 Minutes	120 Hz Maximum	M (1.0)	P (0.1)	R (0.01)	S (0.001)	G (1.0)	B (0.1)	C (0.01)	D (0.001)	Part Number		
20	0.9	A	T111A904K020AS	0.3	4	0265	0485	0705	0925	6042	3042	4042	5042	T213A904K020(1)S		
20	1.1	A	T111A115J020AS	0.4	4											
20	1.1	A	T111A115K020AS	0.4	4	0266	0486	0706	0926	6043	3043	4043	5043	T213A115K020(1)S		
20	1.1	A	T111A115M020AS	0.4	4	0267	0487	0707	0927	6044	3044	4044	5044	T213A115M020(1)S		
20	4.1	B	T111B415K020AS	1.0	6	0268	0488	0708	0928	6045	3045	4045	5045	T213B415K020(1)S		
20	5.0	B	T111B505K020AS	1.0	6	0269	0489	0709	0929	6046	3046	4046	5046	T213B505K020(1)S		
20	5.0	B	T111B505M020AS	1.0	6	0270	0490	0710	0930	6047	3047	4047	5047	T213B505M020(1)S		
20	6.0	B	T111B605K020AS	1.0	6	0271	0491	0711	0931	6048	3048	4048	5048	T213B605K020(1)S		
20	7.5	B	T111B755K020AS	2.0	6	0272	0492	0712	0932	6049	3049	4049	5049	T213B755K020(1)S		
20	7.5	B	T111B755M020AS	2.0	6	0273	0493	0713	0933	6050	3050	4050	5050	T213B755M020(1)S		
20	13.0	C	T111C136K020AS	2.5	6	0274	0494	0714	0934	6051	3051	4051	5051	T213C136K020(1)S		
20	16.0	C	T111C166K020AS	3.0	6	0275	0495	0715	0935	6052	3052	4052	5052	T213C166K020(1)S		
20	16.0	C	T111C166M020AS	3.0	6	0276	0496	0716	0936	6053	3053	4053	5053	T213C166M020(1)S		
20	19.0	C	T111C196J020AS	3.0	6											
20	19.0	C	T111C196K020AS	3.0	6	0277	0497	0717	0937	6054	3054	4054	5054	T213C196K020(1)S		
20	23.0	C	T111C236K020AS	4.5	6	0278	0498	0718	0938	6055	3055	4055	5055	T213C236K020(1)S		
20	23.0	C	T111C236M020AS	4.5	6	0279	0499	0719	0939	6056	3056	4056	5056	T213C236M020(1)S		
20	28.0	D	T111D286K020AS	5.5	6	0280	0500	0720	0940	6057	3057	4057	5057	T213D286K020(1)S		
20	34.0	D	T111D346K020AS	6.0	6	0281	0501	0721	0941	6058	3058	4058	5058	T213D346K020(1)S		
20	34.0	D	T111D346M020AS	6.0	6	0282	0502	0722	0942	6059	3059	4059	5059	T213D346M020(1)S		
20	41.0	D	T111D416K020AS	6.0	6	0283	0503	0723	0943	6060	3060	4060	5060	T213D416K020(1)S		
20	50.0	D	T111D506J020AS	10.0	6											
20	50.0	D	T111D506K020AS	10.0	6	0284	0504	0724	0944	6061	3061	4061	5061	T213D506K020(1)S		
20	50.0	D	T111D506M020AS	10.0	6	0285	0505	0725	0945	6062	3062	4062	5062	T213D506M020(1)S		
35	0.1	A	T111A114J035AS		4											
35	2.8	B	T111B285K035AS	1.0	4	0289	0509	0729	0949	6063	3063	4063	5063	T213B285K035(1)S		
35	3.4	B	T111B345K035AS	1.5	4	0290	0510	0730	0950	6064	3064	4064	5064	T213B345K035(1)S		
35	3.4	B	T111B345M035AS	1.5	4	0291	0511	0731	0951	6065	3065	4065	5065	T213B345M035(1)S		
35	5.0	C	T111C505M035AS	2.5	4											
35	11.0	C	T111C116J035AS	4.0	4											
35	11.0	C	T111C116K035AS	4.0	4	0292	0512	0732	0952	6066	3066	4066	5066	T213C116K035(1)S		
35	11.0	C	T111C116M035AS	4.0	4	0293	0513	0733	0953	6067	3067	4067	5067	T213C116M035(1)S		
35	13.0	D	T111D136K035AS	4.5	4	0294	0514	0734	0954	6068	3068	4068	5068	T213D136K035(1)S		
35	16.0	D	T111D166K035AS	5.5	4	0295	0515	0735	0955	6069	3069	4069	5069	T213D166K035(1)S		
35	16.0	D	T111D166M035AS	5.5	4	0296	0516	0736	0956	6070	3070	4070	5070	T213D166M035(1)S		
35	19.0	D	T111D196K035AS	6.0	4	0297	0517	0737	0957	6071	3071	4071	5071	T213D196K035(1)S		
35	23.0	D	T111D236K035AS	8.0	4	0298	0518	0738	0958	6072	3072	4072	5072	T213D236K035(1)S		
35	23.0	D	T111D236M035AS	8.0	4	0299	0519	0739	0959	6073	3073	4073	5073	T213D236M035(1)S		
50	0.0023	A	T111A232K050AS	0.1	2	1171	1241	1311	1381	6074	3074	4074	5074	T213A232K050(1)S		
50	0.0023	A	T111A232M050AS	0.1	2	1172	1242	1312	1382	6075	3075	4075	5075	T213A232M050(1)S		
50	0.0028	A	T111A282K050AS	0.1	2	1173	1243	1313	1383	6076	3076	4076	5076	T213A282K050(1)S		
50	0.0034	A	T111A342K050AS	0.1	2	1174	1244	1314	1384	6077	3077	4077	5077	T213A342K050(1)S		
50	0.0034	A	T111A342M050AS	0.1	2	1175	1245	1315	1385	6078	3078	4078	5078	T213A342M050(1)S		
50	0.0041	A	T111A412K050AS	0.1	2	1176	1246	1316	1386	6079	3079	4079	5079	T213A412K050(1)S		
50	0.005	A	T111A502K050AS	0.1	2	1177	1247	1317	1387	6080	3080	4080	5080	T213A502K050(1)S		
(V) 85°C	µF		(see below for part options)	µA at 25°C Max/5 Minimum	120 Hz Maximum	M (1.0)	P (0.1)	R (0.01)	S (0.001)	G (1.0)	B (0.1)	C (0.01)	D (0.001)	Part Number		
Rated Voltage	Rated Cap	Case Size Code	KEMET Part Number	DC Leakage	DF % at 25°C	MIL-PRF-39003 (CSR13) Capacitors										

(1) To complete KEMET part number, insert failure rate code from Ordering Information table.

**Table 1 – Ratings & Part Number Reference cont.**

Rated Voltage	Rated Cap	Case Size Code	KEMET Part Number	DC Leakage	DF % at 25°C	MIL-PRF-39003 (CSR91) Capacitors										KEMET Equivalent Military
						Dash Number Reference								Part Number		
						Failure Rate Level (%/1,000 hours)										
						MIL-PRF-39003/4C				MIL-PRF-39003/4C						
						Exponential				Graded						
(V) 85°C	µF		(See below for part options)	µA at 25°C Max/5 Minutes	120 Hz Maximum	M (1.0)	P (0.1)	R (0.01)	S (0.001)	G (1.0)	B (0.1)	C (0.01)	D (0.001)	Part Number		
50	0.005	A	T111A502M050AS	0.1	2	1178	1248	1318	1388	6081	3081	4081	5081	T213A502M050(1)S		
50	0.006	A	T111A602K050AS	0.1	2	1179	1249	1319	1389	6082	3082	4082	5082	T213A602K050(1)S		
50	0.0075	A	T111A752K050AS	0.1	2	1180	1250	1320	1390	6083	3083	4083	5083	T213A752K050(1)S		
50	0.0075	A	T111A752M050AS	0.1	2	1181	1251	1321	1391	6084	3084	4084	5084	T213A752M050(1)S		
50	0.009	A	T111A902K050AS	0.1	2	1182	1252	1322	1392	6085	3085	4085	5085	T213A902K050(1)S		
50	0.011	A	T111A113K050AS	0.1	2	1183	1253	1323	1393	6086	3086	4086	5086	T213A113K050(1)S		
50	0.011	A	T111A113M050AS	0.1	2	1184	1254	1324	1394	6087	3087	4087	5087	T213A113M050(1)S		
50	0.013	A	T111A133K050AS	0.1	2	1185	1255	1325	1395	6088	3088	4088	5088	T213A133K050(1)S		
50	0.016	A	T111A163J050AS	0.1	2											
50	0.016	A	T111A163K050AS	0.1	2	1186	1256	1326	1396	6089	3089	4089	5089	T213A163K050(1)S		
50	0.016	A	T111A163M050AS	0.1	2	1187	1257	1327	1397	6090	3090	4090	5090	T213A163M050(1)S		
50	0.019	A	T111A193K050AS	0.1	2	1188	1258	1328	1398	6091	3091	4091	5091	T213A193K050(1)S		
50	0.023	A	T111A233J050AS	0.1	2											
50	0.023	A	T111A233K050AS	0.1	2	1189	1259	1329	1399	6092	3092	4092	5092	T213A233K050(1)S		
50	0.023	A	T111A233M050AS	0.1	2	1190	1260	1330	1400	6093	3093	4093	5093	T213A233M050(1)S		
50	0.028	A	T111A283K050AS	0.1	2	1191	1261	1331	1401	6094	3094	4094	5094	T213A283K050(1)S		
50	0.034	A	T111A343K050AS	0.1	2	1192	1262	1332	1402	6095	3095	4095	5095	T213A343K050(1)S		
50	0.034	A	T111A343M050AS	0.1	2	1193	1263	1333	1403	6096	3096	4096	5096	T213A343M050(1)S		
50	0.041	A	T111A413K050AS	0.1	2	1194	1264	1334	1404	6097	3097	4097	5097	T213A413K050(1)S		
50	0.05	A	T111A503K050AS	0.3	2	1195	1265	1335	1405	6098	3098	4098	5098	T213A503K050(1)S		
50	0.05	A	T111A503M050AS	0.3	2	1196	1266	1336	1406	6099	3099	4099	5099	T213A503M050(1)S		
50	0.06	A	T111A603K050AS	0.3	2	1197	1267	1337	1407	6100	3100	4100	5100	T213A603K050(1)S		
50	0.075	A	T111A753J050AS	0.3	2											
50	0.075	A	T111A753K050AS	0.3	2	1198	1268	1338	1408	6101	3101	4101	5101	T213A753K050(1)S		
50	0.075	A	T111A753M050AS	0.3	2	1199	1269	1339	1409	6102	3102	4102	5102	T213A753M050(1)S		
50	0.09	A	T111A903K050AS	0.3	2	1200	1270	1340	1410	6103	3103	4103	5103	T213A903K050(1)S		
50	0.11	A	T111A114J050AS	0.3	2											
50	0.11	A	T111A114K050AS	0.3	2	1201	1271	1341	1411	6104	3104	4104	5104	T213A114K050(1)S		
50	0.11	A	T111A114M050AS	0.3	2	1202	1272	1342	1412	6105	3105	4105	5105	T213A114M050(1)S		
50	0.13	A	T111A134K050AS	0.3	2	1203	1273	1343	1413	6106	3106	4106	5106	T213A134K050(1)S		
50	0.16	A	T111A164K050AS	0.3	2	1204	1274	1344	1414	6107	3107	4107	5107	T213A164K050(1)S		
50	0.16	A	T111A164M050AS	0.3	2	1205	1275	1345	1415	6108	3108	4108	5108	T213A164M050(1)S		
50	0.19	A	T111A194K050AS	0.3	2	1206	1276	1346	1416	6109	3109	4109	5109	T213A194K050(1)S		
50	0.23	A	T111A234K050AS	0.3	2	1207	1277	1347	1417	6110	3110	4110	5110	T213A234K050(1)S		
50	0.23	A	T111A234M050AS	0.3	2	1208	1278	1348	1418	6111	3111	4111	5111	T213A234M050(1)S		
50	0.28	A	T111A284K050AS	0.3	2	1209	1279	1349	1419	6112	3112	4112	5112	T213A284K050(1)S		
50	0.34	A	T111A344K050AS	0.3	2	1210	1280	1350	1420	6113	3113	4113	5113	T213A344K050(1)S		
50	0.34	A	T111A344M050AS	0.3	2	1211	1281	1351	1421	6114	3114	4114	5114	T213A344M050(1)S		
50	0.41	A	T111A414K050AS	0.3	2	0300	0520	0740	0960	6115	3115	4115	5115	T213A414K050(1)S		
50	0.5	A	T111A504J050AS	0.4	2											
50	0.5	A	T111A504K050AS	0.4	2	0301	0521	0741	0961	6116	3116	4116	5116	T213A504K050(1)S		
50	0.5	A	T111A504M050AS	0.4	2	0302	0522	0742	0962	6117	3117	4117	5117	T213A504M050(1)S		
50	0.6	B	T111B604J050AS	0.4	4											
50	0.6	B	T111B604K050AS	0.4	4	1212	1282	1352	1422	6118	3118	4118	5118	T213B604K050(1)S		
50	0.6	B	T111B604M050AS	0.4	4											
(V) 85°C	µF		(see below for part options)	µA at 25°C Max/5 Minimum	120 Hz Maximum	M (1.0)	P (0.1)	R (0.01)	S (0.001)	G (1.0)	B (0.1)	C (0.01)	D (0.001)	Part Number		
Rated Voltage	Rated Cap	Case Size Code	KEMET Part Number	DC Leakage	DF % at 25°C	MIL-PRF-39003 (CSR13) Capacitors										

(1) To complete KEMET part number, insert failure rate code from Ordering Information table.

**Table 1 – Ratings & Part Number Reference cont.**

Rated Voltage	Rated Cap	Case Size Code	KEMET Part Number	DC Leakage	DF % at 25°C	MIL-PRF-39003 (CSR91) Capacitors										KEMET Equivalent Military
						Dash Number Reference								KEMET Equivalent Military		
						Failure Rate Level (%/1,000 hours)										
						MIL-PRF-39003/4C				MIL-PRF-39003/4C						
						Exponential				Graded						
(V) 85°C	µF		(See below for part options)	µA at 25°C Max/5 Minutes	120 Hz Maximum	M (1.0)	P (0.1)	R (0.01)	S (0.001)	G (1.0)	B (0.1)	C (0.01)	D (0.001)	Part Number		
50	0.75	B	T111B754K050AS	0.5	4	2001	2101	2201	2301	6119	3119	4119	5119	T213B754K050(1)S		
50	0.75	B	T111B754M050AS	0.5	4	2002	2102	2202	2302	6120	3120	4120	5120	T213B754M050(1)S		
50	0.9	B	T111B904K050AS	0.5	4	1215	1285	1355	1425	6121	3121	4121	5121	T213B904K050(1)S		
50	0.9	B	T111B904M050AS	0.5	4											
50	1.1	B	T111B115J050AS	0.8	4											
50	1.1	B	T111B115K050AS	0.8	4	1216	1286	1356	1426	6122	3122	4122	5122	T213B115K050(1)S		
50	1.1	B	T111B115M050AS	0.8	4	1217	1287	1357	1427	6123	3123	4123	5123	T213B115M050(1)S		
50	1.3	B	T111B135K050AS	1.0	4	1218	1288	1358	1428	6124	3124	4124	5124	T213B135K050(1)S		
50	1.3	B	T111B135M050AS	1.0	4											
50	1.6	B	T111B165K050AS	1.2	4	1219	1289	1359	1429	6125	3125	4125	5125	T213B165K050(1)S		
50	1.6	B	T111B165M050AS	1.2	4	1220	1290	1360	1430	6126	3126	4126	5126	T213B165M050(1)S		
50	1.9	B	T111B195J050AS	1.5	4											
50	1.9	B	T111B195K050AS	1.5	4	1221	1291	1361	1431	6127	3127	4127	5127	T213B195K050(1)S		
50	1.9	B	T111B195M050AS	1.5	4											
50	2.3	B	T111B235K050AS	1.7	4	1222	1292	1362	1432	6128	3128	4128	5128	T213B235K050(1)S		
50	2.3	B	T111B235M050AS	1.7	4	1223	1293	1363	1433	6129	3129	4129	5129	T213B235M050(1)S		
50	2.8	C	T111C285K050AS	2.2	4	1224	1294	1364	1434	6130	3130	4130	5130	T213C285K050(1)S		
50	2.8	C	T111C285M050AS	2.2	4											
50	3.4	C	T111C345K050AS	2.2	4	1225	1295	1365	1435	6131	3131	4131	5131	T213C345K050(1)S		
50	3.4	C	T111C345M050AS	2.2	4	1226	1296	1366	1436	6132	3132	4132	5132	T213C345M050(1)S		
50	4.1	C	T111C415K050AS	2.5	4	1227	1297	1367	1437	6133	3133	4133	5133	T213C415K050(1)S		
50	4.1	C	T111C415M050AS	2.5	4											
50	5.0	C	T111C505J050AS	2.5	4											
50	5.0	C	T111C505K050AS	2.5	4	1228	1298	1368	1438	6134	3134	4134	5134	T213C505K050(1)S		
50	5.0	C	T111C505M050AS	2.5	4	1229	1299	1369	1439	6135	3135	4135	5135	T213C505M050(1)S		
50	6.0	C	T111C605K050AS	3.0	4	0303	0523	0743	0963	6136	3136	4136	5136	T213C605K050(1)S		
50	6.0	C	T111C605M050AS	3.0	4											
50	7.5	C	T111C755K050AS	4.1	4	0304	0524	0744	0964	6137	3137	4137	5137	T213C755K050(1)S		
50	7.5	C	T111C755M050AS	4.1	4	0305	0525	0745	0965	6138	3138	4138	5138	T213C755M050(1)S		
50	9.0	C	T111C905K050AS	4.5	4	0306	0526	0746	0966	6139	3139	4139	5139	T213C905K050(1)S		
50	9.0	C	T111C905M050AS	4.5	4											
50	11.0	D	T111D116K050AS	5.5	4	0307	0527	0747	0967	6140	3140	4140	5140	T213D116K050(1)S		
50	11.0	D	T111D116M050AS	5.5	4	0308	0528	0748	0968	6141	3141	4141	5141	T213D116M050(1)S		
75	0.34	A	T111A344K075AS	0.3	2	0309	0529	0749	0969	6142	3142	4142	5142	T213A344K075(1)S		
75	0.34	A	T111A344M075AS	0.3	2	0310	0530	0750	0970	6143	3143	4143	5143	T213A344M075(1)S		
75	0.41	B	T111B414K075AS	0.3	2	2008	2108	2208	2308	6144	3144	4144	5144	T213B414K075(1)S		
75	0.5	B	T111B504K075AS	0.4	2	2009	2109	2209	2309	6145	3145	4145	5145	T213B504K075(1)S		
75	0.5	B	T111B504M075AS	0.4	2	2010	2110	2210	2310	6146	3146	4146	5146	T213B504M075(1)S		
75	0.6	B	T111B604K075AS	0.4	4	2011	2111	2211	2311	6147	3147	4147	5147	T213B604K075(1)S		
75	0.75	B	T111B754K075AS	0.6	4	2012	2112	2212	2312	6148	3148	4148	5148	T213B754K075(1)S		
75	0.75	B	T111B754M075AS	0.6	4	2013	2113	2213	2313	6149	3149	4149	5149	T213B754M075(1)S		
75	0.9	B	T111B904K075AS	0.7	4	2014	2114	2214	2314	6150	3150	4150	5150	T213B904K075(1)S		
75	1.1	B	T111B115K075AS	0.8	4	2015	2115	2215	2315	6151	3151	4151	5151	T213B115K075(1)S		
75	1.1	B	T111B115M075AS	0.8	4	2016	2116	2216	2316	6152	3152	4152	5152	T213B115M075(1)S		
75	1.3	B	T111B135K075AS	1.0	4	2017	2117	2217	2317	6153	3153	4153	5153	T213B135K075(1)S		
(V) 85°C	µF		(see below for part options)	µA at 25°C Max/5 Minimum	120 Hz Maximum	M (1.0)	P (0.1)	R (0.01)	S (0.001)	G (1.0)	B (0.1)	C (0.01)	D (0.001)	Part Number		
Rated Voltage	Rated Cap	Case Size Code	KEMET Part Number	DC Leakage	DF % at 25°C	MIL-PRF-39003 (CSR13) Capacitors										

(1) To complete KEMET part number, insert failure rate code from Ordering Information table.

**Table 1 – Ratings & Part Number Reference cont.**

Rated Voltage	Rated Cap	Case Size Code	KEMET Part Number	DC Leakage	DF % at 25°C	MIL-PRF-39003 (CSR91) Capacitors										KEMET Equivalent Military
						Dash Number Reference										
						Failure Rate Level (%/1,000 hours)										
						MIL-PRF-39003/4C					MIL-PRF-39003/4C					
						Exponential					Graded					
(V) 85°C	µF		(See below for part options)	µA at 25°C Max/5 Minutes	120 Hz Maximum	M (1.0)	P (0.1)	R (0.01)	S (0.001)	G (1.0)	B (0.1)	C (0.01)	D (0.001)	Part Number		
75	1.6	B	T111B165K075AS	1.2	4	0311	0531	0751	0971	6154	3154	4154	5154	T213B165K075(1)S		
75	1.6	B	T111B165M075AS	1.2	4	0312	0532	0752	0972	6155	3155	4155	5155	T213B165M075(1)S		
75	1.9	B	T111B195J075AS	1.5	4											
75	1.9	B	T111B195K075AS	1.5	4	0313	0533	0753	0973	6156	3156	4156	5156	T213B195K075(1)S		
75	2.3	C	T111C235K075AS	3.0	4	2003	2103	2203	2303	6157	3157	4157	5157	T213C235K075(1)S		
75	2.3	C	T111C235M075AS	3.0	4	2004	2104	2204	2304	6158	3158	4158	5158	T213C235M075(1)S		
75	2.8	C	T111C285K075AS	3.0	4	2005	2105	2205	2305	6159	3159	4159	5159	T213C285K075(1)S		
75	3.4	C	T111C345K075AS	5.0	4	2006	2106	2206	2306	6160	3160	4160	5160	T213C345K075(1)S		
75	3.4	C	T111C345M075AS	5.0	4	2007	2107	2207	2307	6161	3161	4161	5161	T213C345M075(1)S		
75	4.1	C	T111C415K075AS	5.0	4	0314	0534	0754	0974	6162	3162	4162	5162	T213C415K075(1)S		
75	5.0	C	T111C505J075AS	5.0	4											
75	5.0	C	T111C505K075AS	5.0	4	0315	0535	0755	0975	6163	3163	4163	5163	T213C505K075(1)S		
75	5.0	C	T111C505M075AS	5.0	4	0316	0536	0756	0976	6164	3164	4164	5164	T213C505M075(1)S		
75	6.0	D	T111D605K075AS	5.0	4	0317	0537	0757	0977	6165	3165	4165	5165	T213D605K075(1)S		
75	7.5	D	T111D755K075AS	7.0	4	0318	0538	0758	0978	6166	3166	4166	5166	T213D755K075(1)S		
75	7.5	D	T111D755M075AS	7.0	4	0319	0539	0759	0979	6167	3167	4167	5167	T213D755M075(1)S		
100	0.0023	A	T111A232K100AS	0.3	2	0320	0540	0760	0980	6168	3168	4168	*	T213A232K100(1)S		
100	0.0023	A	T111A232M100AS	0.3	2	0321	0541	0761	0981	6169	3169	4169	*	T213A232M100(1)S		
100	0.0028	A	T111A282K100AS	0.3	2	0322	0542	0762	0982	6170	3170	4170	*	T213A282K100(1)S		
100	0.0034	A	T111A342K100AS	0.3	2	0323	0543	0763	0983	6171	3171	4171	*	T213A342K100(1)S		
100	0.0034	A	T111A342M100AS	0.3	2	0324	0544	0764	0984	6172	3172	4172	*	T213A342M100(1)S		
100	0.0041	A	T111A412K100AS	0.3	2	0325	0545	0765	0985	6173	3173	4173	*	T213A412K100(1)S		
100	0.0050	A	T111A502J100AS	0.3	2											
100	0.005	A	T111A502K100AS	0.3	2	0326	0546	0766	0986	6174	3174	4174	*	T213A502K100(1)S		
100	0.005	A	T111A502M100AS	0.3	2	0327	0547	0767	0987	6175	3175	4175	*	T213A502M100(1)S		
100	0.006	A	T111A602K100AS	0.3	2	0328	0548	0768	0988	6176	3176	4176	*	T213A602K100(1)S		
100	0.0075	A	T111A752K100AS	0.3	2	0329	0549	0769	0989	6177	3177	4177	*	T213A752K100(1)S		
100	0.0075	A	T111A752M100AS	0.3	2	0330	0550	0770	0990	6178	3178	4178	*	T213A752M100(1)S		
100	0.009	A	T111A902K100AS	0.3	2	0331	0551	0771	0991	6179	3179	4179	*	T213A902K100(1)S		
100	0.011	A	T111A113K100AS	0.3	2	0332	0552	0772	0992	6180	3180	4180	*	T213A113K100(1)S		
100	0.011	A	T111A113M100AS	0.3	2	0333	0553	0773	0993	6181	3181	4181	*	T213A113M100(1)S		
100	0.013	A	T111A133K100AS	0.3	2	0334	0554	0774	0994	6182	3182	4182	*	T213A133K100(1)S		
100	0.016	A	T111A163K100AS	0.3	2	0335	0555	0775	0995	6183	3183	4183	*	T213A163K100(1)S		
100	0.016	A	T111A163M100AS	0.3	2	0336	0556	0776	0996	6184	3184	4184	*	T213A163M100(1)S		
100	0.019	A	T111A193K100AS	0.3	2	0337	0557	0777	0997	6185	3185	4185	*	T213A193K100(1)S		
100	0.023	A	T111A233K100AS	0.3	2	0338	0558	0778	0998	6186	3186	4186	*	T213A233K100(1)S		
100	0.023	A	T111A233M100AS	0.3	2	0339	0559	0779	0999	6187	3187	4187	*	T213A233M100(1)S		
100	0.028	A	T111A283K100AS	0.3	2	0340	0560	0780	1000	6188	3188	4188	*	T213A283K100(1)S		
100	0.034	A	T111A343K100AS	0.3	2	0341	0561	0781	1001	6189	3189	4189	*	T213A343K100(1)S		
100	0.034	A	T111A343M100AS	0.3	2	0342	0562	0782	1002	6190	3190	4190	*	T213A343M100(1)S		
100	0.041	A	T111A413K100AS	0.3	2	0343	0563	0783	1003	6191	3191	4191	*	T213A413K100(1)S		
100	0.050	A	T111A503K100AS	0.3	2	0344	0564	0784	1004	6192	3192	4192	*	T213A503K100(1)S		
100	0.050	A	T111A503M100AS	0.3	2	0345	0565	0785	1005	6193	3193	4193	*	T213A503M100(1)S		
100	0.060	A	T111A603K100AS	0.3	2	0346	0566	0786	1006	6194	3194	4194	*	T213A603K100(1)S		
100	0.075	A	T111A753K100AS	0.3	2	0347	0567	0787	1007	6195	3195	4195	*	T213A753K100(1)S		
(V) 85°C	µF		(see below for part options)	µA at 25°C Max/5 Minimum	120 Hz Maximum	M (1.0)	P (0.1)	R (0.01)	S (0.001)	G (1.0)	B (0.1)	C (0.01)	D (0.001)	Part Number		
Rated Voltage	Rated Cap	Case Size Code	KEMET Part Number	DC Leakage	DF % at 25°C	MIL-PRF-39003 (CSR13) Capacitors										

(1) To complete KEMET part number, insert failure rate code from Ordering Information table.



**Table 1 – Ratings & Part Number Reference cont.**

Rated Voltage	Rated Cap	Case Size Code	KEMET Part Number	DC Leakage	DF % at 25°C	MIL-PRF-39003 (CSR91) Capacitors										KEMET Equivalent Military
						Dash Number Reference								Part Number		
						Failure Rate Level (%/1,000 hours)										
						MIL-PRF-39003/4C				MIL-PRF-39003/4C						
						Exponential				Graded						
(V) 85°C	µF		(See below for part options)	µA at 25°C Max/5 Minutes	120 Hz Maximum	M (1.0)	P (0.1)	R (0.01)	S (0.001)	G (1.0)	B (0.1)	C (0.01)	D (0.001)			
100	0.075	A	T111A753M100AS	0.3	2	0348	0568	0788	1008	6196	3196	4196	*	T213A753M100(1)S		
100	0.09	A	T111A903K100AS	0.3	2	0349	0569	0789	1009	6197	3197	4197	*	T213A903K100(1)S		
100	0.11	A	T111A114K100AS	0.3	2	0350	0570	0790	1010	6198	3198	4198	*	T213A114K100(1)S		
100	0.11	A	T111A114M100AS	0.3	2	0351	0571	0791	1011	6199	3199	4199	*	T213A114M100(1)S		
100	0.13	A	T111A134K100AS	0.3	2	0352	0572	0792	1012	6200	3200	4200	*	T213A134K100(1)S		
100	0.16	A	T111A164J100AS	0.3	2											
100	0.16	A	T111A164K100AS	0.3	2	0353	0573	0793	1013	6201	3201	4201	*	T213A164K100(1)S		
100	0.16	A	T111A164M100AS	0.3	2	0354	0574	0794	1014	6202	3202	4202	*	T213A164M100(1)S		
100	0.19	A	T111A194K100AS	0.3	2	0355	0575	0795	1015	6203	3203	4203	*	T213A194K100(1)S		
100	0.23	A	T111A234K100AS	0.3	2	0356	0576	0796	1016	6204	3204	4204	*	T213A234K100(1)S		
100	0.23	A	T111A234M100AS	0.3	2	0357	0577	0797	1017	6205	3205	4205	*	T213A234M100(1)S		
100	0.28	A	T111A284K100AS	0.3	2	0358	0578	0798	1018	6206	3206	4206	*	T213A284K100(1)S		
100	0.34	B	T111B344K100AS	0.3	2	0359	0579	0799	1019	6207	3207	4207	*	T213B344K100(1)S		
100	0.34	B	T111B344M100AS	0.3	2	0360	0580	0800	1020	6208	3208	4208	*	T213B344M100(1)S		
100	0.41	B	T111B414K100AS	0.4	2	0361	0581	0801	1021	6209	3209	4209	*	T213B414K100(1)S		
100	0.5	B	T111B504K100AS	0.5	2	0362	0582	0802	1022	6210	3210	4210	*	T213B504K100(1)S		
100	0.5	B	T111B504M100AS	0.5	2	0363	0583	0803	1023	6211	3211	4211	*	T213B504M100(1)S		
100	0.6	B	T111B604K100AS	0.5	3	0364	0584	0804	1024	6212	3212	4212	*	T213B604K100(1)S		
100	0.75	B	T111B754K100AS	0.7	3	0365	0585	0805	1025	6213	3213	4213	*	T213B754K100(1)S		
100	0.8	B	T111B754M100AS	0.7	3	0366	0586	0806	1026	6214	3214	4214	*	T213B754M100(1)S		
100	0.9	B	T111B904K100AS	0.7	3	0367	0587	0807	1027	6215	3215	4215	*	T213B904K100(1)S		
100	1.1	B	T111B115K100AS	0.9	3	0368	0588	0808	1028	6216	3216	4216	*	T213B115K100(1)S		
100	1.1	B	T111B115M100AS	0.9	3	0369	0589	0809	1029	6217	3217	4217	*	T213B115M100(1)S		
100	1.3	B	T111B135K100AS	1.1	3	0370	0590	0810	1030	6218	3218	4218	*	T213B135K100(1)S		
(V) 85°C	µF	Case Size Code	(see below for part options)	µA at 25°C Max/5 Minimum	120 Hz Maximum	M (1.0)	P (0.1)	R (0.01)	S (0.001)	G (1.0)	B (0.1)	C (0.01)	D (0.001)	Part Number		
Rated Voltage	Rated Cap		KEMET Part Number	DC Leakage	DF % at 25°C	MIL-PRF-39003 (CSR13) Capacitors										

(1) To complete KEMET part number, insert failure rate code from Ordering Information table.

## Ripple Current/Ripple Voltage

Permissible AC ripple voltage is related to the ESR of the capacitor and the power dissipation capabilities of a particular case size.

Thermal capacities for the various case sizes have been determined empirically and are listed below.

Temperature Compensation Multipliers for Maximum Power Dissipation		
T ≤ 25°C	T ≤ 85°C	T ≤ 125°C
1.00	0.90	0.40

*T = Environmental Temperature*

Permissible AC ripple current can be determined by the following:

$$I(max) = Z \sqrt{P_{max}/R}$$

*P max = maximum watts*

*R = ESR at specified frequency (ohms)*

*I = rms ripple current (amperes)*

*Z = capacitor impedance in ohms at the specified frequency*

Case Size	Maximum Power Dissipation (P max)	T2XX
A	0.09	0.070
B	0.100	0.090
C	0.125	–
D	0.180	–

*Maximum Power Dissipation: 25°C Ambient*

## Optimum Solder Wave Profile

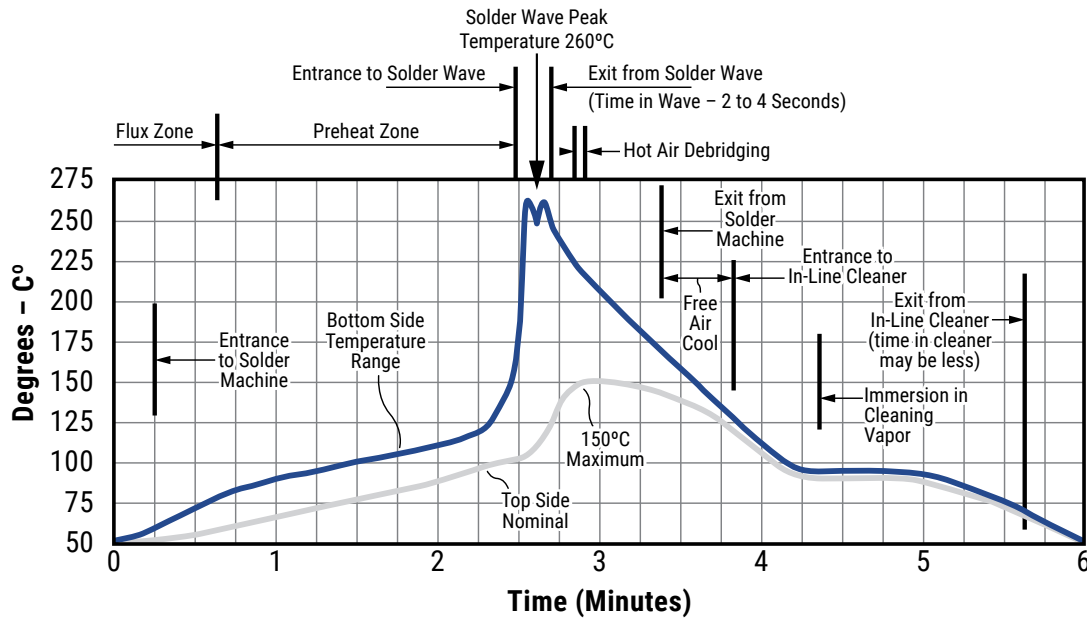

## Mounting

All enclosed capacitors will pass the Resistance to Soldering Heat Test of MIL-STD-202, Method 210, Condition C. This test simulates wave solder of topside board mount product. This demonstration of resistance to solder heat is in accordance with what is believed to be the industry standard. More severe treatment must be considered reflective of an improper soldering process. The above figure is a recommended solder wave profile for both axial and radial leaded solid tantalum capacitors.

## Construction

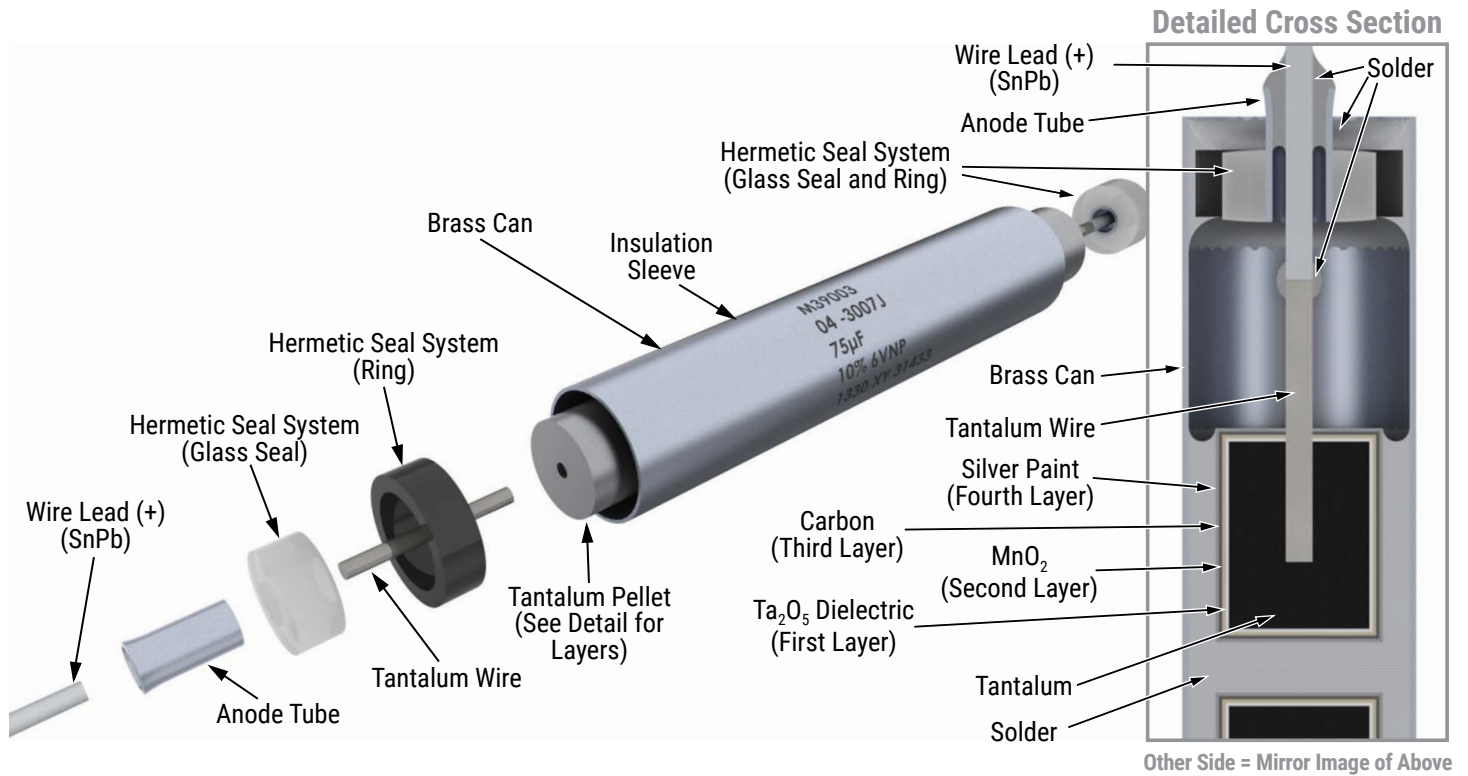

## Capacitor Marking

### T111

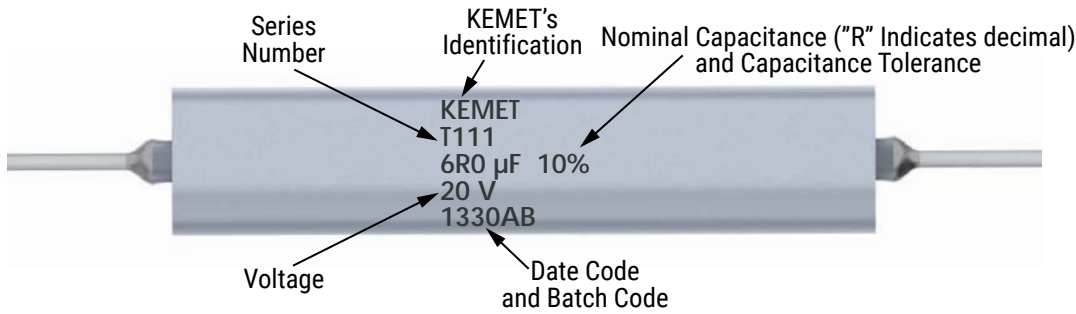

### T213 – A, B, C, and D Case

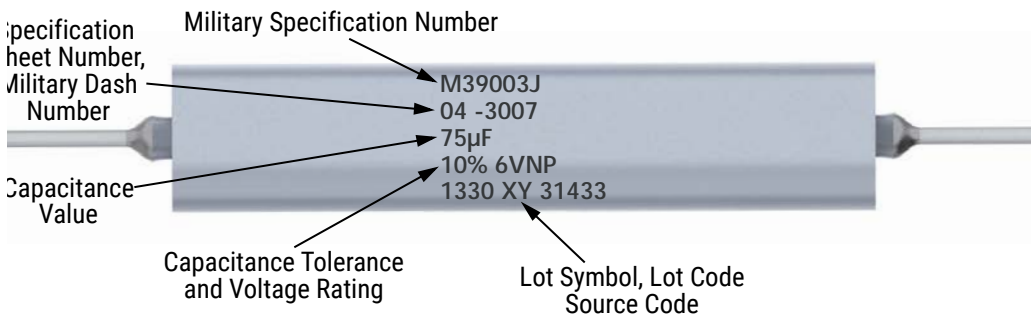

Date Code	3 Digit	4 Digit
Year	9 = 2019 0 = 2020 1 = 2021 2 = 2022 3 = 2023	19 = 2019 20 = 2020 21 = 2021 22 = 2022 23 = 2023
Week	01 = 1 <sup>st</sup> week of the year to 52 = 52 <sup>nd</sup> week of the year	

## Storage

Tantalum hermetically sealed capacitors should be stored in normal working environments. While the capacitors themselves are quite robust in other environments, solderability will be degraded by exposure to high temperatures, high humidity, corrosive atmospheres, and long term storage. In addition, packaging materials will be degraded by high temperature – reels may soften or warp and tape peel force may increase. KEMET recommends that maximum storage temperature not exceed 40°C and maximum storage humidity not exceed 60% relative humidity. Temperature fluctuations should be minimized to avoid condensation on the parts and atmospheres should be free of chlorine and sulphur bearing compounds. For optimized solderability capacitors stock should be used promptly, preferably within three years of receipt.

## Tape & Reel Packaging Information

KEMET offers standard reeling of Solid Tantalum Capacitors for automatic insertion or lead forming machines per EIA Specification RS-296E.

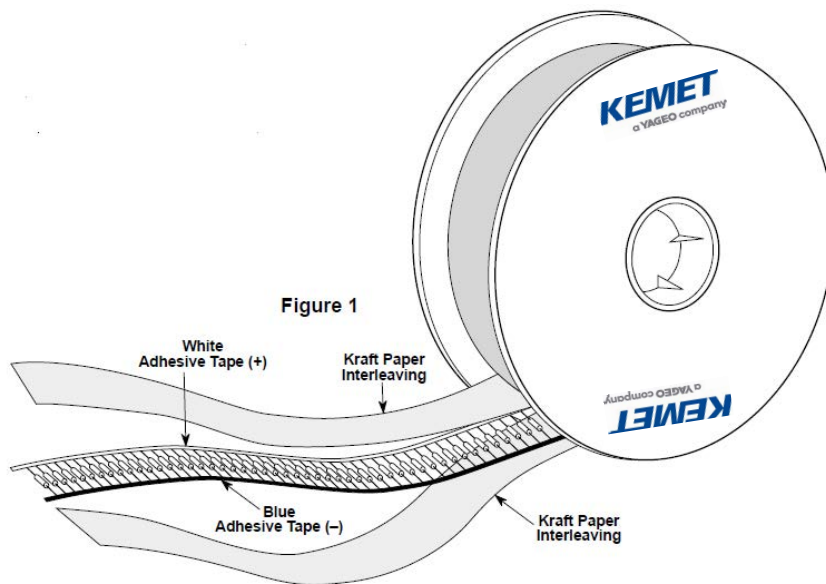

**Table 2 – Packaging Quantity**

Case Size	Standard Bulk Quantity	Standard Reel Quantity	Reel C-Spec	Ammo Pack Quantity	Ammo Pack C-Spec
A	60/Box	3,000	C-7200	N/A	N/A
B	30/Box	2,000	C-7200		
C	10/Card	N/A	N/A		
D	10/Card	N/A	N/A		

**Figure 2**

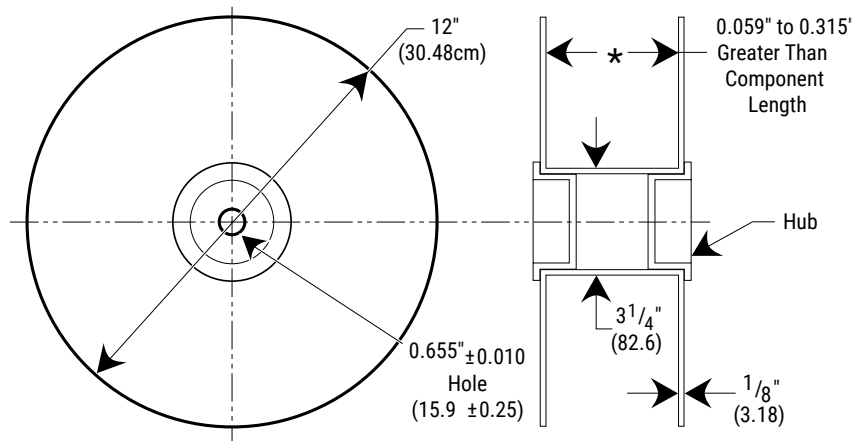

**Figure 3**

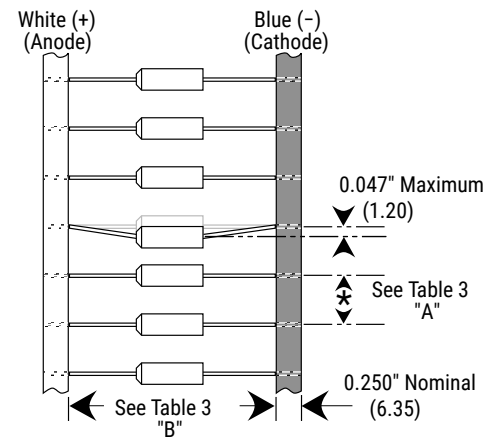

**Table 3 – Tape Dimensions**

Component Body Diameter	Component Pitch "A"	Inside Tape Spacing "B" ±1.5 mm (0.059")		
		I	II	III
0" (0 mm) to 0.197" (5 mm)	0.020" or (±0.5 mm)	2.062"	2.500"	2.874"
0.197" (5.01 mm) to 0.394" (10 mm)	0.200" or (5 mm)	(52.4 mm)	(63.5 mm)	(73 mm)

Capacitors are reeled so that positive leads are oriented as shown in Figure 3. Kraft paper (50lb. test minimum) is inserted between the layers of capacitors wound on reels for component pitch  $\leq 0.200$ " sizes and corrugated paper (70 lb. test minimum), single faced is inserted for component pitch  $\geq 0.400$ " sizes. Capacitor lead length may extend only a maximum of 0.031" (0.8 mm) beyond the tape's edges. Capacitors are centered in a row between the two tapes and will deviate only  $\pm 0.031$ " (0.79 mm) from the row center. Figures 1 and 2 show the KEMET standard chipboard tape reel. A minimum of 36" (91.5 cm) leader tape is provided at each end of the reeled capacitors. Universal splicing clips are used to connect the tape.

## KEMET Electronics Corporation Sales Offices

For a complete list of our global sales offices, please visit [www.kemet.com/sales](http://www.kemet.com/sales).

---

### Disclaimer

YAGEO Corporation and its affiliates do not recommend the use of commercial or automotive grade products for high reliability applications or manned space flight.

All product specifications, statements, information and data (collectively, the "Information") in this datasheet are subject to change. The customer is responsible for checking and verifying the extent to which the Information contained in this publication is applicable to an order at the time the order is placed. All Information given herein is believed to be accurate and reliable, but it is presented without guarantee, warranty, or responsibility of any kind, expressed or implied.

Statements of suitability for certain applications are based on KEMET Electronics Corporation's ("KEMET") knowledge of typical operating conditions for such applications, but are not intended to constitute – and KEMET specifically disclaims – any warranty concerning suitability for a specific customer application or use. The Information is intended for use only by customers who have the requisite experience and capability to determine the correct products for their application. Any technical advice inferred from this Information or otherwise provided by KEMET with reference to the use of KEMET's products is given gratis, and KEMET assumes no obligation or liability for the advice given or results obtained.

Although KEMET designs and manufactures its products to the most stringent quality and safety standards, given the current state of the art, isolated component failures may still occur. Accordingly, customer applications which require a high degree of reliability or safety should employ suitable designs or other safeguards (such as installation of protective circuitry or redundancies) in order to ensure that the failure of an electrical component does not result in a risk of personal injury or property damage.

Although all product-related warnings, cautions and notes must be observed, the customer should not assume that all safety measures are indicated or that other measures may not be required.

*KEMET is a registered trademark of KEMET Electronics Corporation.*