

### Overview

KEMET L-DWI ferrite-based Wire Wound Chip Power Inductors are ideal for use in DC to DC switching power supplies. The small size of this chip inductor and its dimension without directional influence on mountability and characteristics makes it suitable for mobile equipment that requires tight space both in dimension and in height.

### Applications

- Switching DC-DC power supplies
- Wearables
- Smartphone
- Tablet device
- Digital still camera
- HDD

### Benefits

- High current
- Low DCR
- Wide inductance value from 1 – 680  $\mu\text{H}$
- Rated current  $I_{\text{sat}}$  range from 0.065 – 2 A
- Rated current  $I_{\text{rms}}$  range from 0.06 – 1.44 A
- Operating temperature range from  $-40^{\circ}\text{C}$  to  $+105^{\circ}\text{C}$
- Low profile 1.45 – 2.7 mm maximum

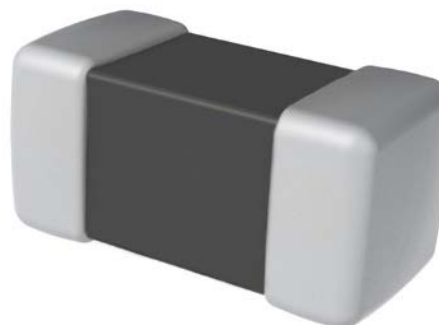

### Part Number System

L	0805	C	1R0	M	DWI	T
Inductor	EIA Case Size (L" x W")	Specification	Inductance Value ( $\mu\text{H}$ )	Inductance Tolerance	Series	Packaging
	0805 (2012 in mm) 0806 (2016 in mm) 1007 (2518 in mm) 1210 (3225 in mm)	C = Commercial R = Low DCR	R = decimal point  Examples: 1R0 = 1.0 $\mu\text{H}$  The first two digits represent the inductance value. The third digit indicates the number of zeros to be added.  Examples: 100 = 10 $\mu\text{H}$ 101 = 100 $\mu\text{H}$	K = $\pm 10\%$ M = $\pm 20\%$	DWI = High current wire wound chip type	T = Tape & Reel

## Dimensions – Millimeters (Inches)

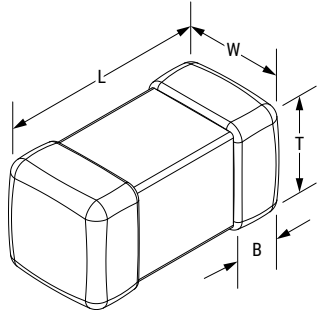
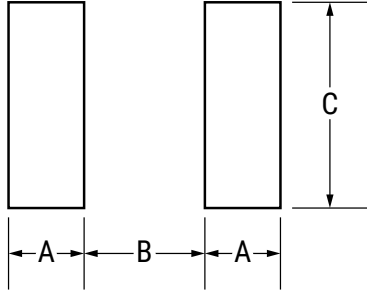
Dimensions - Millimeters (Inches)						Land Pattern - Millimeters		
								
EIA Size Code	Metric Size Code	L Length	W Width	T Thickness	B Bandwidth	A	B	C
0805	2012	2.00 (0.079) ±0.20 (0.008)	1.25 (0.049) ±0.20 (0.008)	1.25 (0.049) ±0.20 (0.008)	0.50 (0.020) ±0.2 (0.008)	0.6	1.0	1.45
0806	2016	2.00 (0.079) ±0.20 (0.008)	1.60 (0.063) ±0.20 (0.008)	1.60 (0.063) ±0.20 (0.008)	0.50 (0.020) ±0.2 (0.008)	0.6	1.0	1.8
1007	2518	2.50 (0.098) ±0.20 (0.008)	1.80 (0.071) ±0.20 (0.008)	1.80 (0.071) ±0.20 (0.008)	0.50 (0.020) ±0.20 (0.008)	0.6	1.5	2.0
1210	3225	3.20 (0.126) ±0.20 (0.008)	2.50 (0.098) ±0.20 (0.008)	2.50 (0.098) ±0.20 (0.008)	0.60 (0.024) ±0.30 (0.012)	0.85	1.7	2.7

## Performance Characteristics

Item	Performance Characteristics
Operating Temperature Range	-40°C to +105°C
Rated Inductance Range	1 – 680 μH
Inductance Tolerance	±10% and ±20%
Rated Current Isat Range	0.065 – 2 A
Rated Current Irms Range	0.06 – 1.44 A
Rated DC Resistance Range Typical	0.055 – 28 Ω
Rated DC Resistance Range Maximum	0.0715 – 36.4 Ω

## Environmental Compliance

All KEMET Chip Inductors are RoHS and REACH Compliant.



**Table 1 – Ratings & Part Number Reference**

Part Number	Inductance (µH)	Inductance Tolerance	DC Resistance (Ω) Typical	DC Resistance (Ω) Maximum	Rated Current I <sub>rms</sub> (A) <sup>1</sup>	Rated Current I <sub>sat</sub> (A) <sup>2</sup>	Self-Resonance Frequency (MHz) Minimum	Inductance Measuring Frequency (MHz)
L0805C1R0MDWIT	1.0	±20%	0.19	0.247	0.84	0.7	100	7.96
L0805C2R2MDWIT	2.2	±20%	0.33	0.429	0.64	0.53	70	7.96
L0805C4R7MDWIT	4.7	±20%	0.5	0.65	0.52	0.36	45	7.96
L0805C100MDWIT	10	±20%	1.2	1.56	0.34	0.24	40	2.52
L0805C220KDWIT	22	±10%	3.7	4.81	0.19	0.17	16	2.52
L0805C220MDWIT	22	±20%	3.7	4.81	0.19	0.17	16	2.52
L0805C470MDWIT	47	±20%	5.8	7.54	0.15	0.12	11	2.52
L0806C1R0MDWIT	1.0	±20%	0.1	0.13	1.1	1.1	100	7.96
L0806C1R5MDWIT	1.5	±20%	0.15	0.195	1	1	80	7.96
L0806C2R2MDWIT	2.2	±20%	0.2	0.26	0.72	0.75	70	7.96
L0806C3R3MDWIT	3.3	±20%	0.27	0.351	0.61	0.6	55	7.96
L0806C4R7MDWIT	4.7	±20%	0.37	0.481	0.53	0.55	45	7.96
L0806C6R8MDWIT	6.8	±20%	0.59	0.767	0.45	0.45	38	7.96
L0806C100KDWIT	10	±10%	0.82	1.066	0.35	0.38	32	2.52
L0806C100MDWIT	10	±20%	0.82	1.066	0.35	0.38	32	2.52
L0806C150MDWIT	15	±20%	1.2	1.56	0.3	0.3	28	2.52
L0806C220KDWIT	22	±10%	1.8	2.34	0.24	0.25	16	2.52
L0806C220MDWIT	22	±20%	1.8	2.34	0.24	0.25	16	2.52
L0806C330MDWIT	33	±20%	2.8	3.64	0.22	0.22	14	2.52
L0806C470KDWIT	47	±10%	4.3	5.59	0.15	0.15	11	2.52
L0806C470MDWIT	47	±20%	4.3	5.59	0.15	0.15	11	2.52
L0806C680MDWIT	68	±20%	7	9.1	0.13	0.13	10	2.52
L0806C101KDWIT	100	±10%	8	10.4	0.11	0.11	8	0.796
L0806C101MDWIT	100	±20%	8	10.4	0.11	0.11	8	0.796
L1007C1R0MDWIT	1.0	±20%	0.08	0.104	1.2	1	100	7.96
L1007C1R5MDWIT	1.5	±20%	0.11	0.143	1.19	0.95	80	7.96
L1007C2R2MDWIT	2.2	±20%	0.13	0.169	1.1	0.89	68	7.96
L1007C3R3MDWIT	3.3	±20%	0.16	0.208	1.02	0.73	54	7.96
L1007C4R7MDWIT	4.7	±20%	0.2	0.26	0.92	0.68	41	7.96
L1007C6R8MDWIT	6.8	±20%	0.3	0.39	0.74	0.55	38	7.96
L1007C100KDWIT	10	±10%	0.36	0.468	0.68	0.48	30	2.52
L1007C100MDWIT	10	±20%	0.36	0.468	0.68	0.48	30	2.52
L1007C150KDWIT	15	±10%	0.65	0.845	0.5	0.35	23	2.52
Part Number	Inductance (µH)	Inductance Tolerance	DC Resistance (Ω) Typical	DC Resistance (Ω) Maximum	Rated Current I <sub>rms</sub> (A) <sup>1</sup>	Rated Current I <sub>sat</sub> (A) <sup>2</sup>	Self-Resonance Frequency (MHz) Minimum	Inductance Measuring Frequency (MHz)

<sup>1</sup> T = 40 K rise at rated current at 20°C

<sup>2</sup> Inductance drop 30% at rated current at 20°C

**Table 1 – Ratings & Part Number Reference**

Part Number	Inductance (µH)	Inductance Tolerance	DC Resistance (Ω) Typical	DC Resistance (Ω) Maximum	Rated Current I <sub>rms</sub> (A) <sup>1</sup>	Rated Current I <sub>sat</sub> (A) <sup>2</sup>	Self-Resonance Frequency (MHz) Minimum	Inductance Measuring Frequency (MHz)
L1007C150MDWIT	15	±20%	0.65	0.845	0.5	0.35	23	2.52
L1007C220KDWIT	22	±10%	0.77	1.001	0.46	0.32	19	2.52
L1007C220MDWIT	22	±20%	0.77	1.001	0.46	0.32	19	2.52
L1007C330KDWIT	33	±10%	1.5	1.95	0.32	0.27	15	2.52
L1007C330MDWIT	33	±20%	1.5	1.95	0.32	0.27	15	2.52
L1007C470KDWIT	47	±10%	1.9	2.47	0.29	0.24	12	2.52
L1007C470MDWIT	47	±20%	1.9	2.47	0.29	0.24	12	2.52
L1007C680KDWIT	68	±10%	2.8	3.64	0.2	0.2	9.5	2.52
L1007C680MDWIT	68	±20%	2.8	3.64	0.2	0.2	9.5	2.52
L1007C101KDWIT	100	±10%	3.7	4.81	0.17	0.16	9	0.796
L1007C101MDWIT	100	±20%	3.7	4.81	0.17	0.16	9	0.796
L1007C151KDWIT	150	±10%	6.1	7.93	0.13	0.14	7	0.796
L1007C151MDWIT	150	±20%	6.1	7.93	0.13	0.14	7	0.796
L1007C221KDWIT	220	±10%	8.4	10.92	0.11	0.12	5.5	0.796
L1007C221MDWIT	220	±20%	8.4	10.92	0.11	0.12	5.5	0.796
L1007C331KDWIT	330	±10%	12.3	15.99	0.09	0.1	4.5	0.796
L1007C331MDWIT	330	±20%	12.3	15.99	0.09	0.1	4.5	0.796
L1007C471KDWIT	470	±10%	22	28.6	0.07	0.08	3.5	0.796
L1007C471MDWIT	470	±20%	22	28.6	0.07	0.08	3.5	0.796
L1007C681KDWIT	680	±10%	28	36.4	0.06	0.07	3	0.796
L1007C681MDWIT	680	±20%	28	36.4	0.06	0.07	3	0.796
L1210R1R0MDWIT	1.0	±20%	0.06	0.072	1.44	2	250	0.1
L1210R1R5MDWIT	1.5	±20%	0.06	0.078	1.31	2	250	0.1
L1210R2R2MDWIT	2.2	±20%	0.08	0.104	1.13	2	190	0.1
L1210R3R3MDWIT	3.3	±20%	0.1	0.124	1.04	2	160	0.1
L1210R4R7MDWIT	4.7	±20%	0.1	0.13	1.01	1.25	70	0.1
L1210R6R8MDWIT	6.8	±20%	0.12	0.156	0.94	0.95	50	0.1
L1210R100KDWIT	10	±10%	0.13	0.173	0.9	0.9	23	0.1
L1210R100MDWIT	10	±20%	0.13	0.173	0.9	0.9	23	0.1
L1210R150KDWIT	15	±10%	0.2	0.254	0.85	0.73	20	0.1
L1210R150MDWIT	15	±20%	0.2	0.254	0.85	0.73	20	0.1
L1210R220KDWIT	22	±10%	0.27	0.351	0.78	0.62	17	0.1
L1210R220MDWIT	22	±20%	0.27	0.351	0.78	0.62	17	0.1
L1210R330KDWIT	33	±10%	0.41	0.533	0.57	0.5	13	0.1
L1210R330MDWIT	33	±20%	0.41	0.533	0.57	0.5	13	0.1
L1210R470KDWIT	47	±10%	0.67	0.871	0.48	0.39	10	0.1
L1210R470MDWIT	47	±20%	0.67	0.871	0.48	0.39	10	0.1
L1210R680KDWIT	68	±10%	1	1.3	0.41	0.32	8	0.1
L1210R680MDWIT	68	±20%	1	1.3	0.41	0.32	8	0.1
L1210R101KDWIT	100	±10%	1.4	1.82	0.34	0.27	6	0.1
L1210R101MDWIT	100	±20%	1.4	1.82	0.34	0.27	6	0.1
Part Number	Inductance (µH)	Inductance Tolerance	DC Resistance (Ω) Typical	DC Resistance (Ω) Maximum	Rated Current I <sub>rms</sub> (A) <sup>1</sup>	Rated Current I <sub>sat</sub> (A) <sup>2</sup>	Self-Resonance Frequency (MHz) Minimum	Inductance Measuring Frequency (MHz)

<sup>1</sup> T = 40 K rise at rated current at 20°C

<sup>2</sup> Inductance drop 30% at rated current at 20°C

## DC-Superposed Characteristics

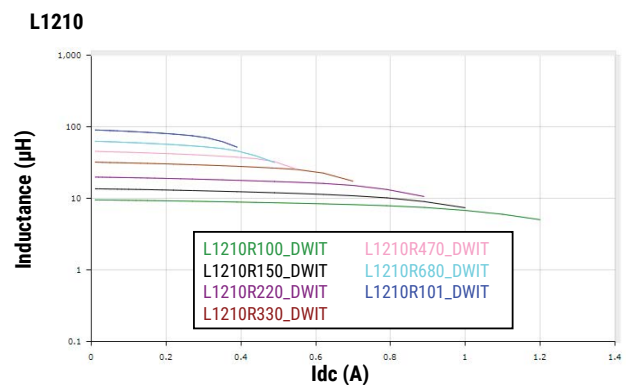
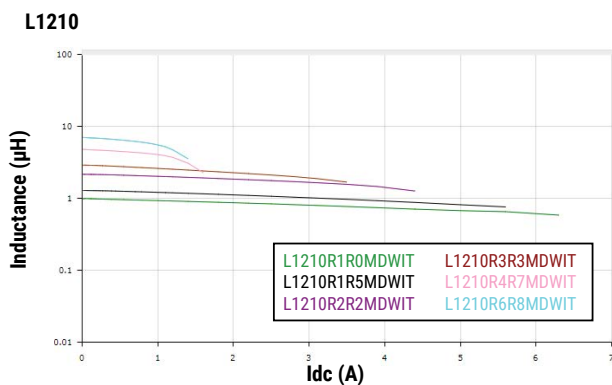
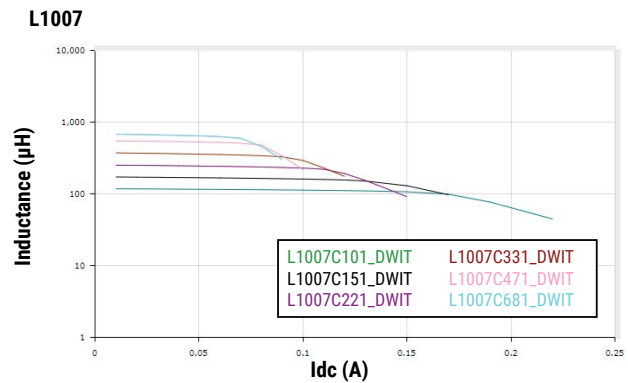
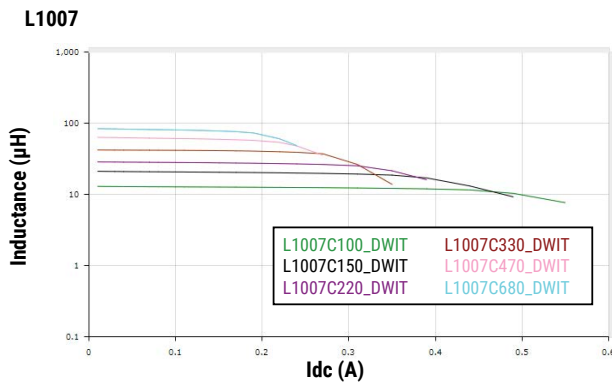
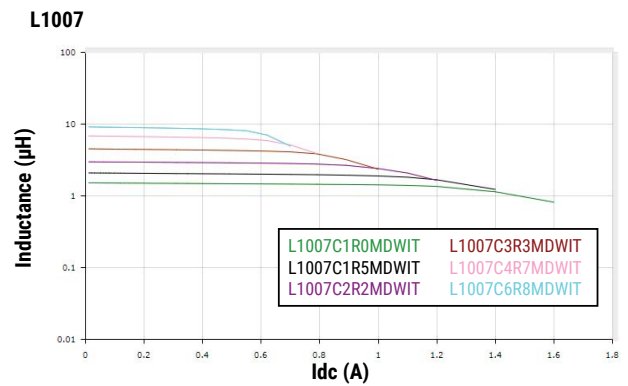
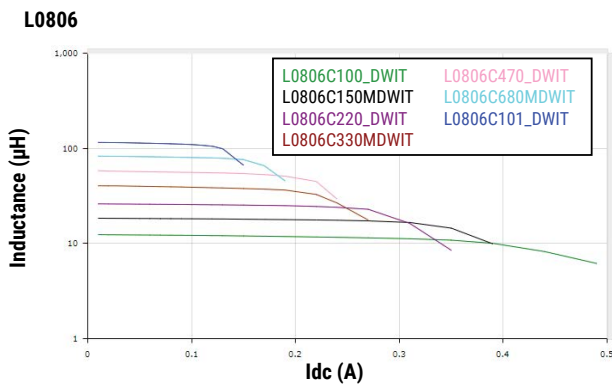
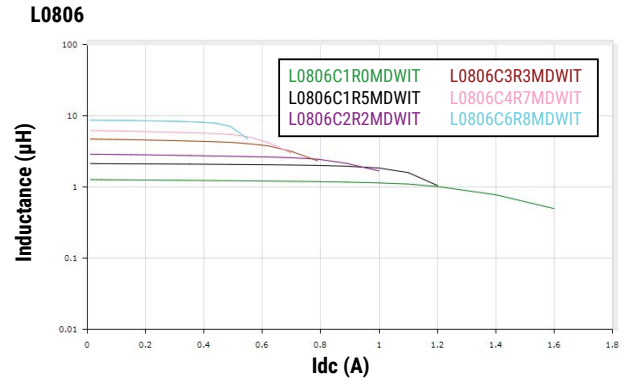
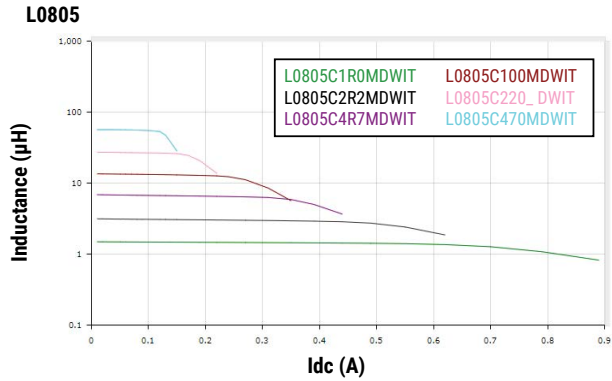

## Inductance versus Frequency Characteristics

L0805

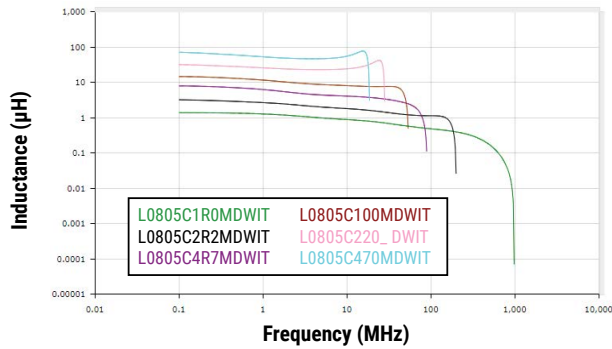

L0806

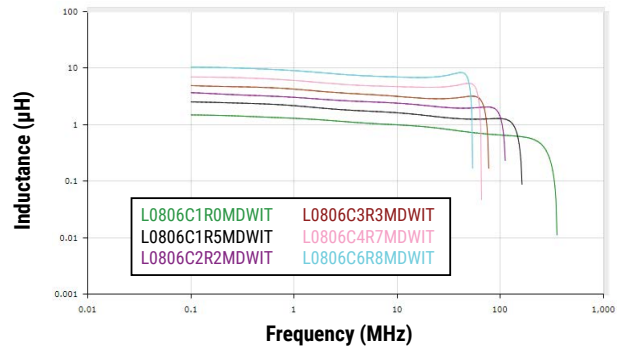

L0806

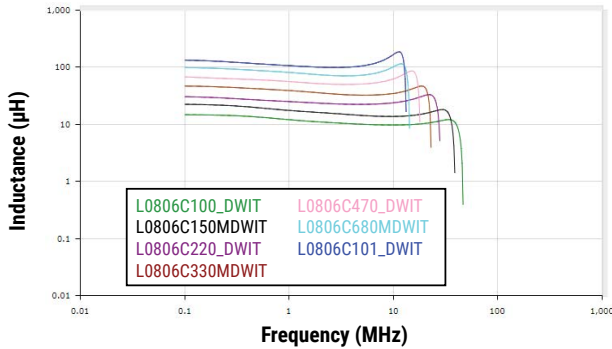

L1007

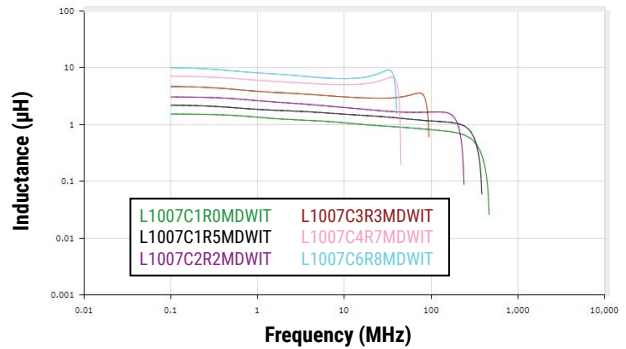

L1007

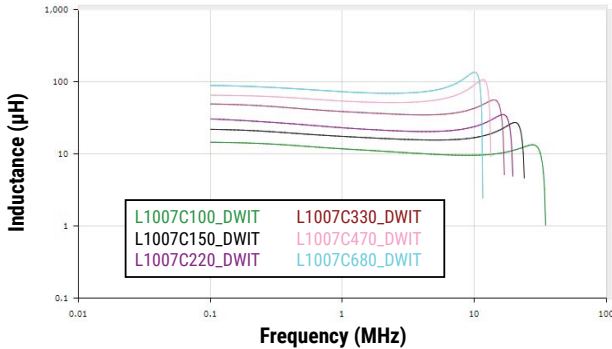

L1007

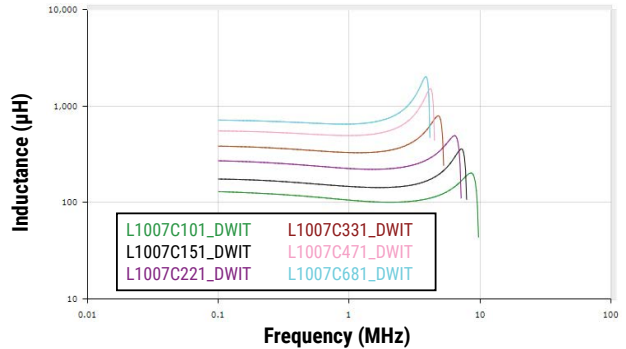

L1210

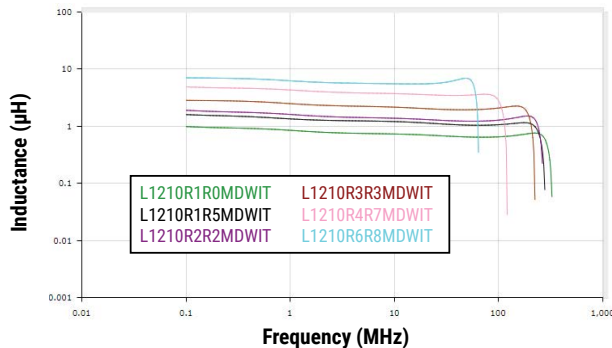

L1210

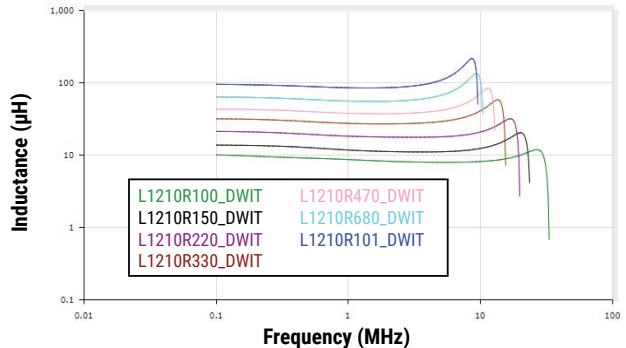

## Taping Specifications - Millimeters (Inches)

### 0805, 0806, 1007 and 1210 Embossed (Plastic) Tape 8mm Width

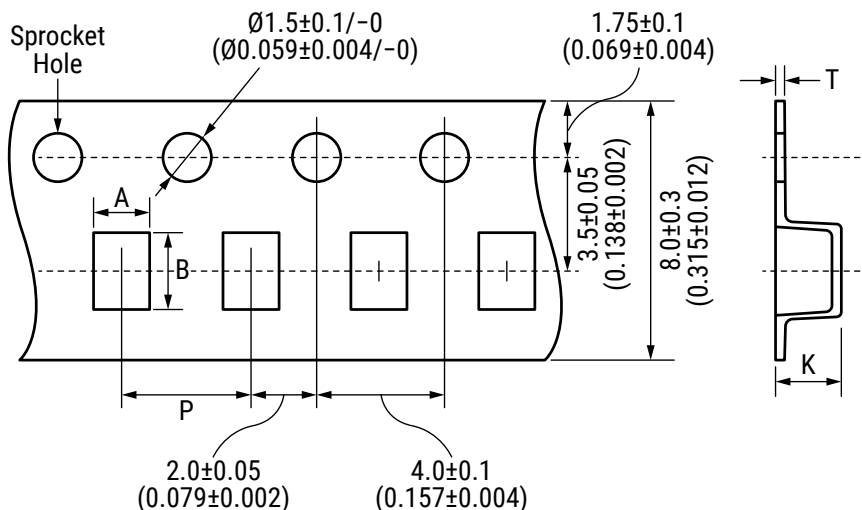

EIA Case Size	Metric Case Size	Height	Reel Quantity		Cavity		Pitch	Thickness	
					A	B	P	T	K
0805	2012	1.25	3,000	Nominal	1.45	2.25	4.00	0.25	1.45
				Tolerance	$\pm 0.1$	$\pm 0.1$	$\pm 0.1$	$\pm 0.05$	Maximum
0806	2016	1.6	2,000	Nominal	1.75	2.10	4.00	0.30	1.90
				Tolerance	$\pm 0.1$	$\pm 0.1$	$\pm 0.1$	$\pm 0.05$	Maximum
1007	2518	1.8	2,000	Nominal	2.15	2.70	4.00	0.30	2.20
				Tolerance	$\pm 0.1$	$\pm 0.1$	$\pm 0.1$	$\pm 0.05$	Maximum
1210	3225	2.5	1,000	Nominal	2.80	3.50	4.00	0.30	4.00
				Tolerance	$\pm 0.1$	$\pm 0.1$	$\pm 0.1$	$\pm 0.05$	Maximum

## Reel Specifications - Millimeters

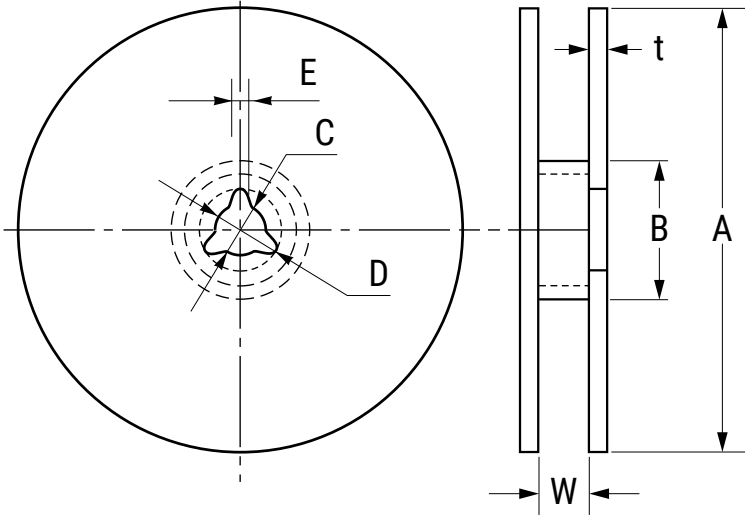

Series		Dimensions - Millimeters						
		A	B	C	D	E	t	W
L-DWI	Nominal	ø180.0	ø60.0	ø13.0	ø21.0	2.0	2.5	10.0
	Tolerance	Maximum	Minimum	±0.5	±0.8	±0.5	Maximum	±1.5



## Recommended Reflow Soldering Profile

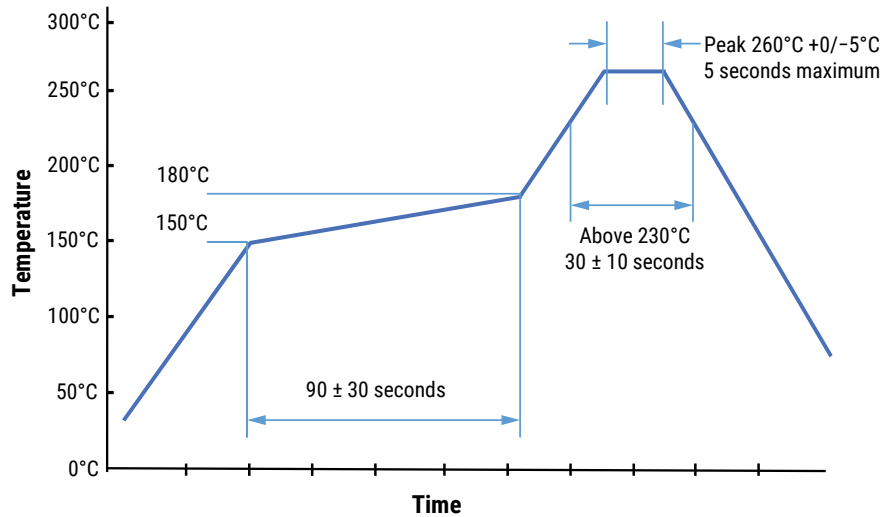

## Handling Precautions

Inductors should be stored in normal working environments. While the inductors themselves are quite robust in other environments, exposure to high temperatures, high humidity, corrosive atmospheres, and long-term storage degrades solderability.

KEMET recommends that maximum storage temperature not exceed  $40^\circ\text{C}$  and maximum storage humidity not exceed 70% relative humidity. Atmospheres should be free of chlorine-bearing and sulfur-bearing compounds. Temperature fluctuations should be minimized to avoid condensation on the parts.

For optimized solderability, inductor stock should be used promptly, preferably within six months of receipt.

## KEMET Electronics Corporation Sales Offices

For a complete list of our global sales offices, please visit [www.kemet.com/sales](http://www.kemet.com/sales).

---

## Disclaimer

YAGEO Corporation and its affiliates do not recommend the use of commercial or automotive grade products for high reliability applications or manned space flight.

All product specifications, statements, information and data (collectively, the "Information") in this datasheet are subject to change. The customer is responsible for checking and verifying the extent to which the Information contained in this publication is applicable to an order at the time the order is placed. All Information given herein is believed to be accurate and reliable, but it is presented without guarantee, warranty, or responsibility of any kind, expressed or implied.

Statements of suitability for certain applications are based on KEMET Electronics Corporation's ("KEMET") knowledge of typical operating conditions for such applications, but are not intended to constitute – and KEMET specifically disclaims – any warranty concerning suitability for a specific customer application or use. The Information is intended for use only by customers who have the requisite experience and capability to determine the correct products for their application. Any technical advice inferred from this Information or otherwise provided by KEMET with reference to the use of KEMET's products is given gratis, and KEMET assumes no obligation or liability for the advice given or results obtained.

Although KEMET designs and manufactures its products to the most stringent quality and safety standards, given the current state of the art, isolated component failures may still occur. Accordingly, customer applications which require a high degree of reliability or safety should employ suitable designs or other safeguards (such as installation of protective circuitry or redundancies) in order to ensure that the failure of an electrical component does not result in a risk of personal injury or property damage.

Although all product-related warnings, cautions and notes must be observed, the customer should not assume that all safety measures are indicated or that other measures may not be required.

When providing KEMET products and technologies contained herein to other countries, the customer must abide by the procedures and provisions stipulated in all applicable export laws and regulations, including without limitation the International Traffic in Arms Regulations (ITAR), the US Export Administration Regulations (EAR) and the Japan Foreign Exchange and Foreign Trade Act.

*KEMET is a registered trademark of KEMET Electronics Corporation.*