



Overview

KEMET's KC-LINK™ with KONNEKT™ technology surface mount capacitors are designed for high-efficiency and high-density power applications. KONNEKT high density packaging technology uses an innovative Transient Liquid Phase Sintering (TLPS) material to create a surface mount multi-chip solution for high density packaging. By utilizing KEMET's robust and proprietary COG base metal electrode (BME) dielectric system, these capacitors are well suited for power converters, inverters, snubbers, and resonators where high efficiency is a primary concern.

KONNEKT technology enables a low-loss, low-inductance package capable of handling extremely high ripple currents with no change in capacitance versus DC voltage

Benefits

- Extremely high-power density and ripple current capability
- Extremely low equivalent series resistance (ESR)
- Extremely low equivalent series inductance (ESL)
- Low-loss orientation option for higher current handling capability
- Capacitance offerings ranging from 14 – 880 nF
- DC voltage ratings from 500 – 2,000 V
- Operating temperature range of -55°C to +150°C
- No capacitance shift with voltage
- No piezoelectric noise
- High thermal stability
- Surface mountable using standard MLCC reflow profiles

Standard



Low Loss

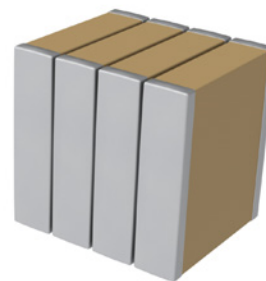

and negligible change in capacitance versus temperature. With an operating temperature range up to 150°C, these capacitors can be mounted close to fast switching semiconductors in high power density applications, which require minimal cooling. KC-LINK with KONNEKT technology also exhibits high mechanical robustness compared to other dielectric technologies, allowing the capacitor to be mounted without the use of metal frames.

These capacitors can also be mounted in a low-loss orientation to further increase power handling capability. The low-loss orientation lowers ESR (Effective Series Resistance) and ESL (Effective Series Inductance) which increases ripple current handling capability.

Applications

- Wide bandgap (WBG), silicon carbide (SiC) and gallium nitride (GaN) systems
- Data centers
- EV/HEV (drive systems, charging)
- LLC resonant converters
- Switched tank converters
- Wireless charging systems
- Photovoltaic systems
- Power converters
- Inverters
- DC link
- Snubber

Ordering Information

CKC	33	C	884	K	C	G	L	C	XXXX
Series	Case Size (L"x W")	Specification/ Series	Capacitance Code (pF)	Capacitance Tolerance	Rated Voltage (V)	Dielectric	Subclass Designation	Termination Finish	Orientation and Packaging (Suffix/C-Spec)
CKC = KC-LINK	18 = 1812 21 = 2220 33 = 3640	C = Standard	Two single digits and number of zeros.	K = ±10%	C = 500 V W = 650 V D = 1,000 V E = 1,200 V J = 1,700 V G = 2,000 V	G = COG	L = KONNEKT	C = 100% matte Sn	See "Packaging C-Spec Ordering Options Table"

Additional termination finish options may be available. Contact KEMET for details.

Orientation and Packaging (Suffix/C-Spec) Options Table

Mounting Orientation ¹	Tape and Reel Illustration	Packaging Type	Packaging/Grade Ordering Code (C-Spec)
Commercial Grade			
Standard		7" Reel/Unmarked	TU
		13" Reel/Unmarked	7210
Low Loss		7" Reel/Unmarked	7805
		13" Reel/Unmarked	7810
Automotive Grade			
Standard		7" Reel/Unmarked	AUTO
		13" Reel/Unmarked	AUTO7210
Low Loss		7" Reel/Unmarked	AUTO7805
		13" Reel/Unmarked	AUTO7810

¹ Orientation refers to the positioning of the KONNEKT capacitors in the Tape and Reel pockets. This allows pick and place machines to place capacitors on the PCB in the correct orientation.

Automotive C-Spec Information

KEMET automotive grade products meet or exceed the requirements outlined by the Automotive Electronics Council. Details regarding test methods and conditions are referenced in document AEC-Q200, Stress Test Qualification for Passive Components. These products are supported by a Product Change Notification (PCN) and Production Part Approval Process warrant (PPAP).

Automotive products offered through our distribution channel have been assigned an inclusive ordering code C-Spec, "AUTO." This C-Spec was developed in order to better serve small and medium-sized companies that prefer an automotive grade component without the requirement to submit a customer Source Controlled Drawing (SCD) or specification for review by a KEMET engineering specialist. This C-Spec is therefore not intended for use by KEMET OEM automotive customers and are not granted the same "privileges" as other automotive C-Specs. Customer PCN approval and PPAP request levels are limited (see details below.)

Product Change Notification (PCN)

The KEMET product change notification system is used to communicate primarily the following types of changes:

- Product/process changes that affect product form, fit, function, and/or reliability
- Changes in manufacturing site
- Product obsolescence

KEMET Automotive C-Spec	Customer Notification Due To:		Days Prior To Implementation
	Process/Product change	Obsolescence*	
KEMET assigned ¹	Yes (with approval and sign off)	Yes	180 days minimum
AUTO	Yes (without approval)	Yes	90 days minimum

¹ KEMET assigned C-Specs require the submittal of a customer SCD or customer specification for review. For additional information contact KEMET.

Production Part Approval Process (PPAP)

The purpose of the Production Part Approval Process is:

- To ensure that supplier can meet the manufacturability and quality requirements for the purchased parts.
- To provide the evidence that all customer engineering design records and specification requirements are properly understood and fulfilled by the manufacturing organization.
- To demonstrate that the established manufacturing process has the potential to produce the part.

KEMET Automotive C-Spec	PPAP (Product Part Approval Process) Level				
	1	2	3	4	5
KEMET assigned ¹	•	•	•	•	•
AUTO	○		○		

¹ KEMET assigned C-Specs require the submittal of a customer SCD or customer specification for review. For additional information contact KEMET.

- Part number specific PPAP available
- Product family PPAP only

Dimensions – Millimeters (Inches)

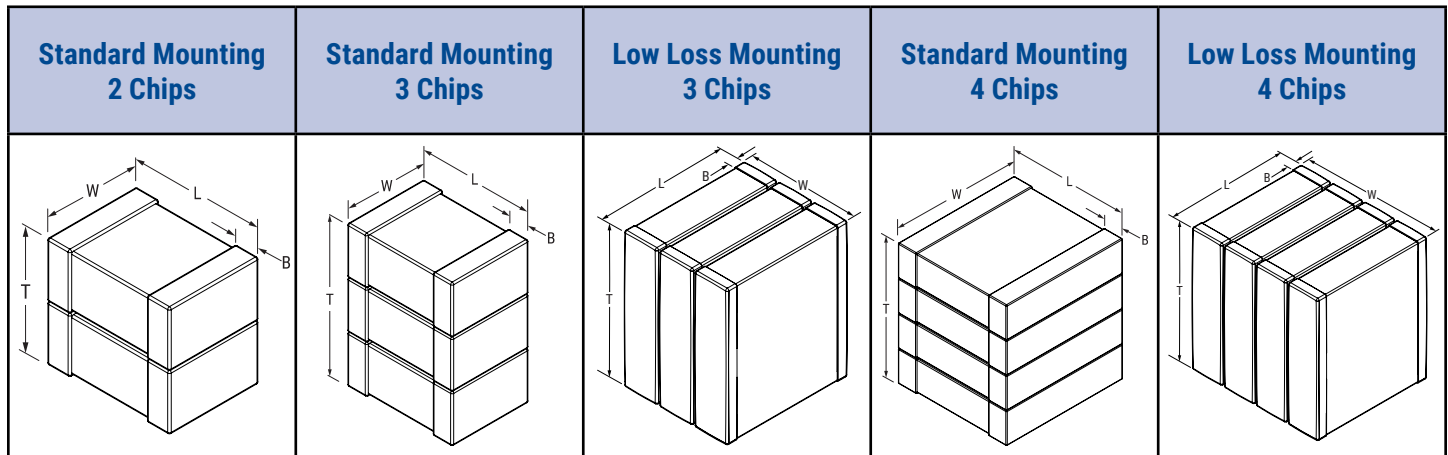

EIA SIZE CODE	METRIC SIZE CODE	Number of Chips	Mounting	L LENGTH	W WIDTH	T THICKNESS	B BANDWIDTH	Mounting Technique	Typical Average Piece Weight (g)
1812	4532	2	Standard	4.50 (0.177) ±0.30 (0.012)	3.20 (0.126) ±0.30 (0.012)	5.10 (0.201) ±0.40 (0.016)	0.60 (0.024) ±0.35 (0.014)	Solder Reflow Only	0.3
		3	Standard		3.20 (0.126) ±0.30 (0.012)	7.70 (0.303) ±0.60 (0.24)			0.45
			Low Loss		7.70 (0.303) ±0.60 (0.24)	3.20 (0.126) ±0.30 (0.012)			0.45
2220	5750	2	Standard	5.70 (0.224) ±0.40 (0.016)	5.00 (0.197) ±0.40 (0.016)	5.00 (0.197) ±0.40 (0.016)	0.60 (0.024) ±0.35 (0.014)	Solder Reflow Only	0.6
			Low Loss		5.10 (0.201) ±0.40 (0.016)	5.00 (0.197) ±0.40 (0.016)			
		3	Standard		5.00 (0.197) ±0.40 (0.016)	7.70 (0.303) ±0.60 (0.24)			1.0
			Low Loss		7.70 (0.303) ±0.60 (0.24)	5.00 (0.197) ±0.40 (0.016)			1.0
		4	Low Loss		10.30 (0.405) ±0.80 (0.031)	5.00 (0.197) ±0.40 (0.016)			1.4
3640	9210	2	Standard	9.30 (0.366) ±0.60 (0.024)	10.20 (0.402) ±0.40 (0.016)	5.10 (0.201) ±0.40 (0.016)	1.27 (0.050) ±0.40 (0.016)	Solder Reflow Only	2.2
		3	Standard		10.20 (0.402) ±0.40 (0.016)	7.70 (0.303) ±0.60 (0.24)			3.3
			Low Loss		7.70 (0.303) ±0.60 (0.24)	10.20 (0.402) ±0.40 (0.016)			3.3
		4	Standard		10.20 (0.402) ±0.40 (0.016)	10.30 (0.405) ±0.80 (0.031)			4.3
			Low Loss		10.30 (0.405) ±0.80 (0.031)	10.20 (0.402) ±0.40 (0.016)			4.3

Environmental Compliance



Lead (Pb)-free, RoHS, and REACH compliant without exemptions.

Typical Performance

Number of Chips	Mounting Configuration	Typical ESR at 25°C, 100 kHz	Typical ESL at 25°C	Typical Ripple Current
2	Standard	< 2.5 mΩ	< 1.5 nH	See Typical Performance Curves Below
3	Standard	< 2.5 mΩ	< 2.2 nH	
3	Low Loss	< 1.6 mΩ	< 0.75 nH	
4	Standard	< 2.5 mΩ	< 2.7 nH	
4	Low Loss	< 1.1 mΩ	< 0.45 nH	

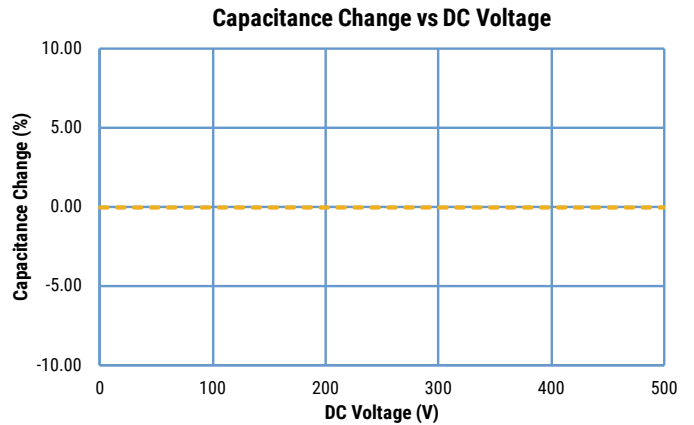
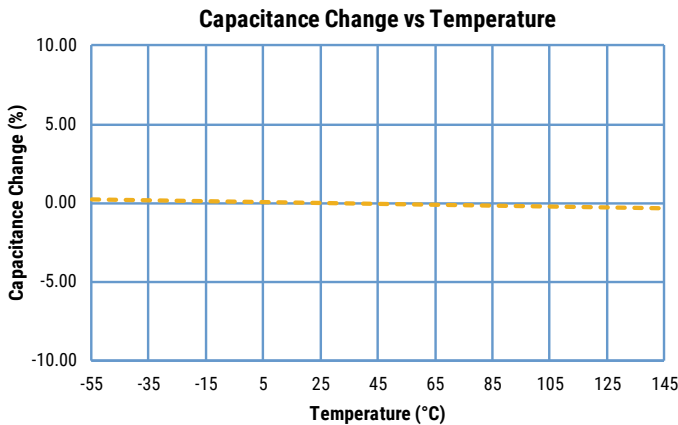

Typical Performance cont.

Standard Orientation

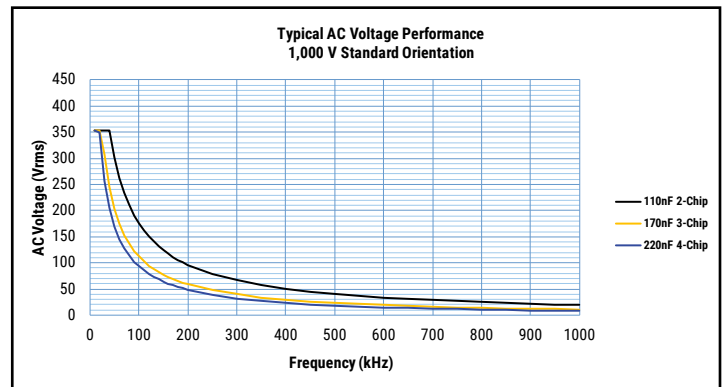
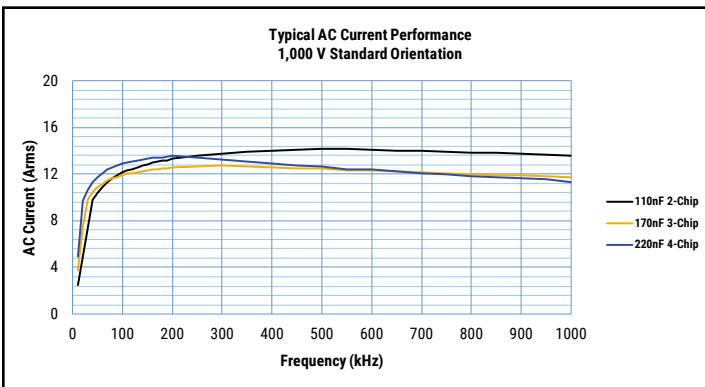
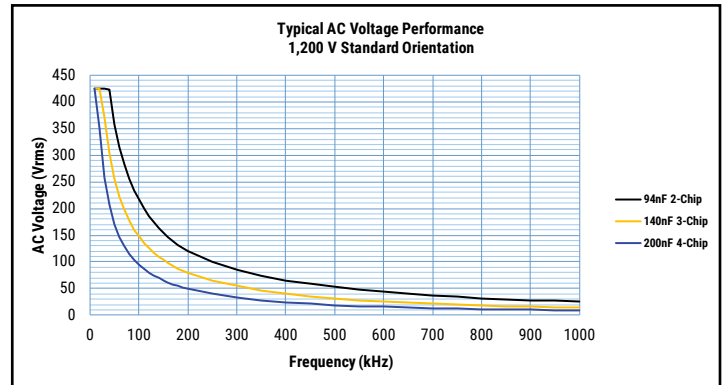
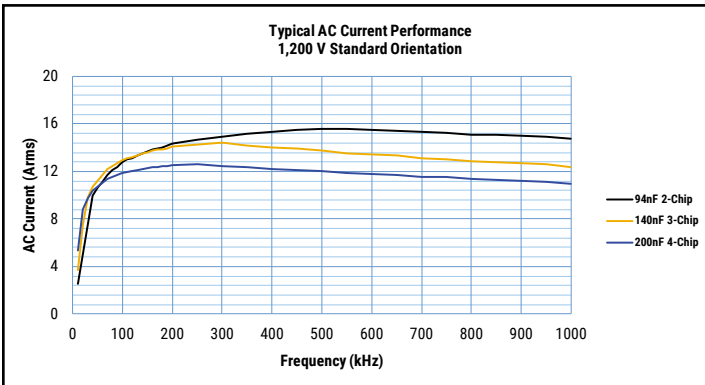
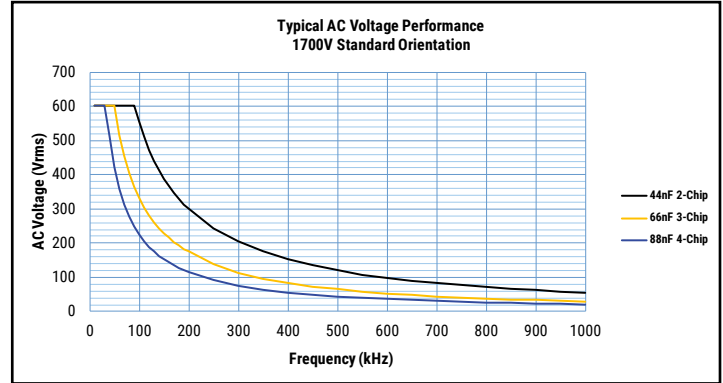
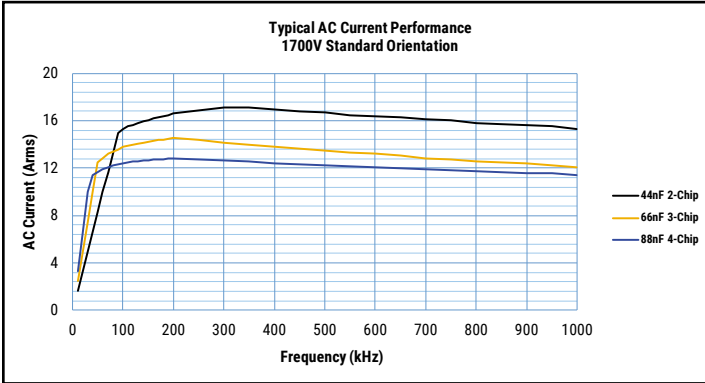

Typical Performance cont.

Standard Orientation

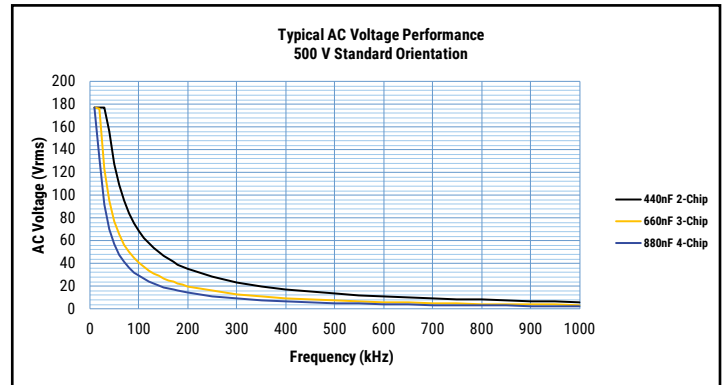
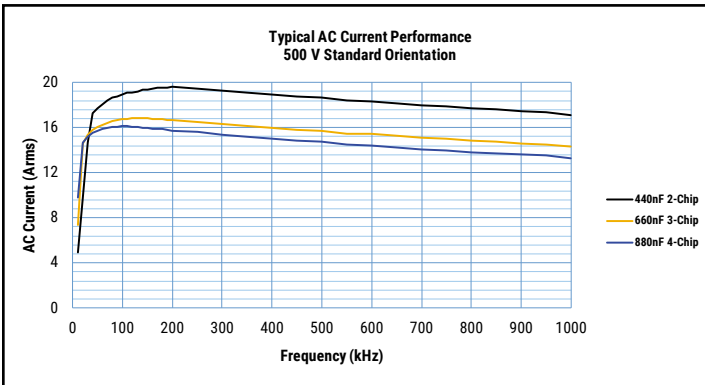
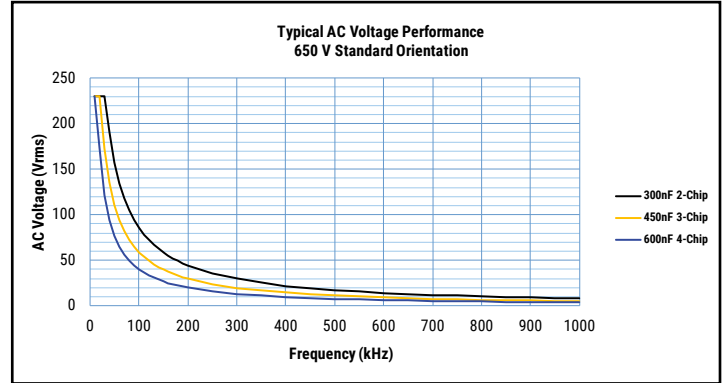
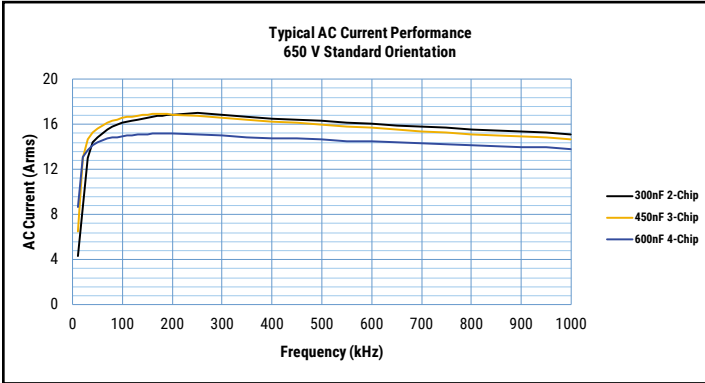

Typical Performance cont.

Low Loss Orientation

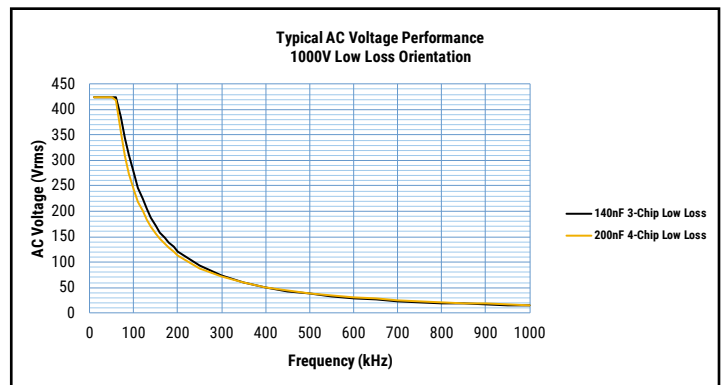
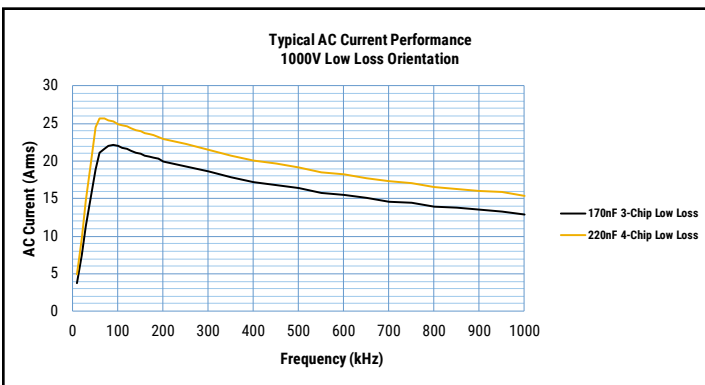
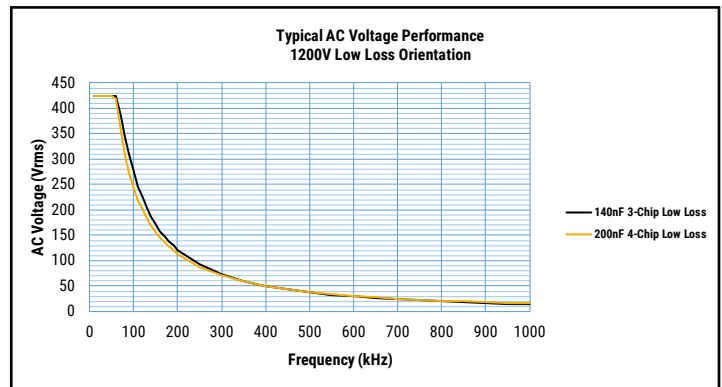
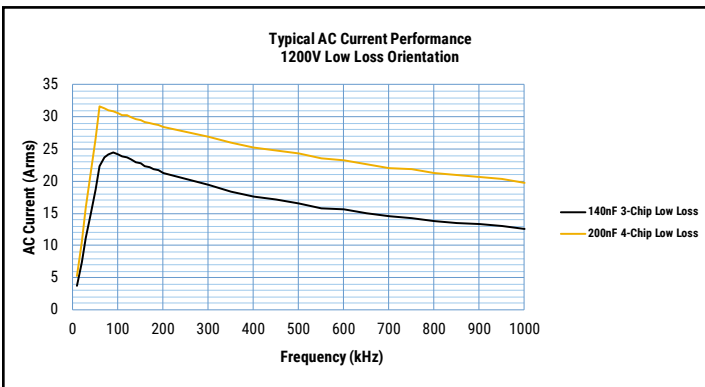
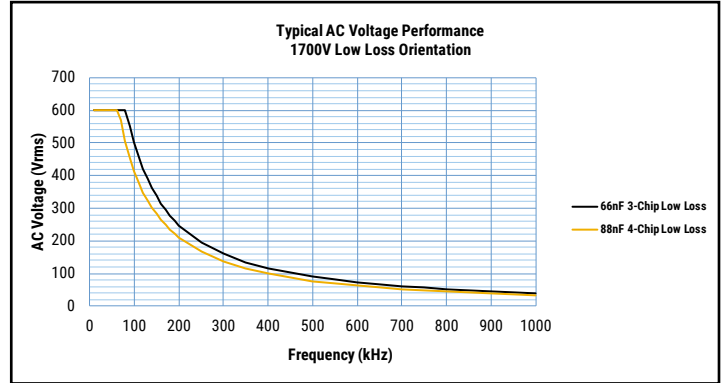
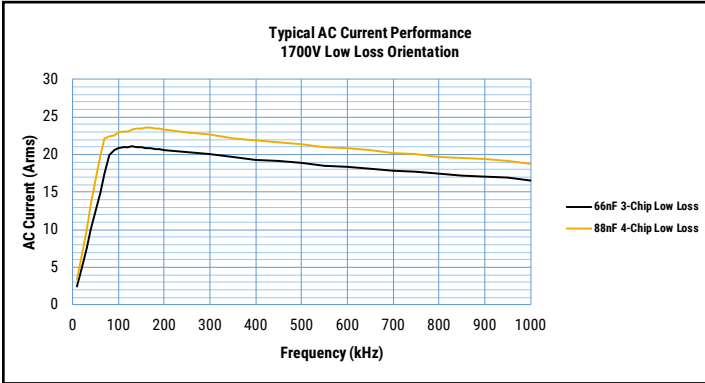

Typical Performance cont.

Low Loss Orientation

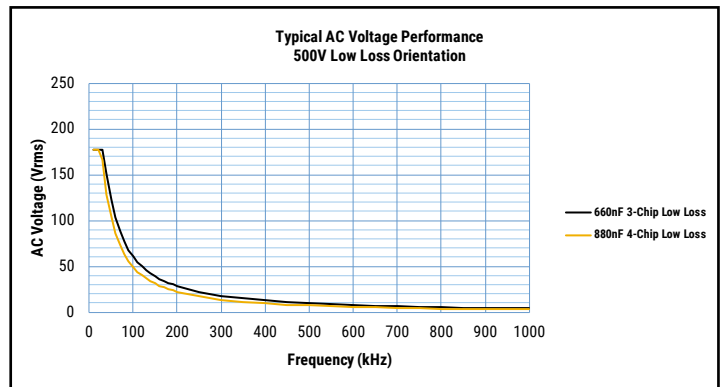
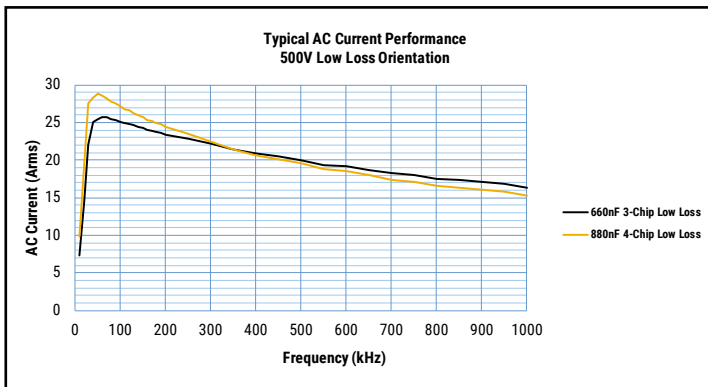
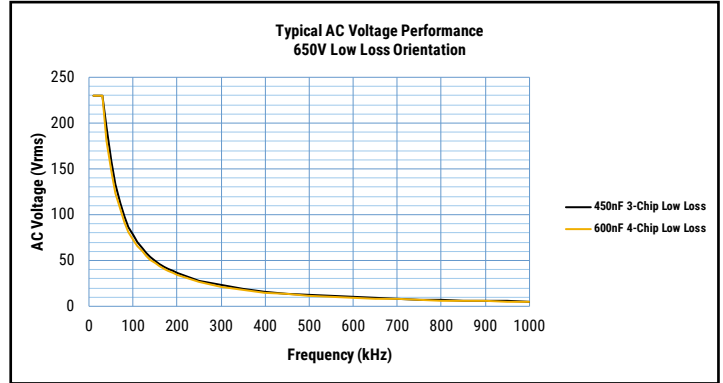
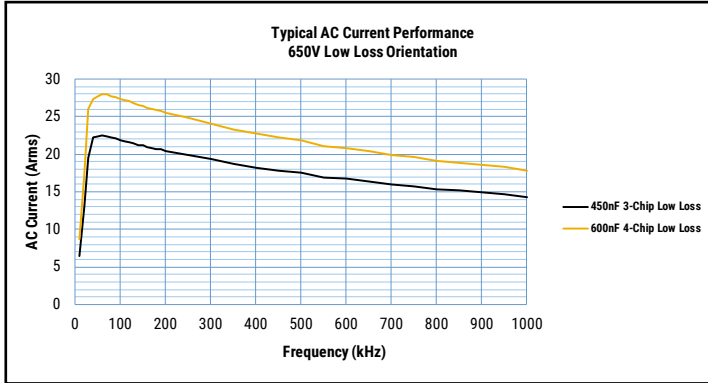

Detailed Part Number List

KEMET Part Number ¹	Case Size	Capacitance	Voltage	Number of Chips	Orientation	Thickness mm (inch)			
CKC18C303KDGLC(a)	1812	30 nF	1,000 V	2	Standard	5.10 (0.201) ±0.40 (0.016)			
CKC18C943KWGLC(a)		94 nF	650 V						
CKC18C943KCGLC(a)		94 nF	500 V	3	Standard Low Loss	Standard: 7.70 (0.303) ±0.60 (0.24) Low Loss: 3.20 (0.126) ±0.30 (0.012)			
CKC18C453KDGLC(a)		45 nF	1,000 V						
CKC18C144KWGLC(a)		140 nF	650 V						
CKC18C144KCGLC(a)		140 nF	500 V						
CKC21C143KJGLC(a)	2220	14 nF	1,700 V	2	Standard Low Loss	5.00 (0.197) ±0.40 (0.016)			
CKC21C243KEGLC(a)		24 nF	1,200 V						
CKC21C663KDGLC(a)		66 nF	1,000 V						
CKC21C204KWGLC(a)		200 nF	650 V						
CKC21C204KCGLC(a)		200 nF	500 V						
CKC21C203KJGLC(a)		20 nF	1,700 V				3	Standard Low Loss	Standard: 7.70 (0.303) ±0.60 (0.24) Low Loss: 5.00 (0.197) ±0.40 (0.016)
CKC21C363KEGLC(a)		36 nF	1,200 V						
CKC21C104KDGLC(a)		100 nF	1,000 V						
CKC21C304KWGLC(a)		300 nF	650 V						
CKC21C304KCGLC(a)		300 nF	500 V	4	Low Loss	5.00 (0.197) ±0.40 (0.016)			
CKC21C273KJGLC(a)		27 nF	1,700 V						
CKC21C483KEGLC(a)		48 nF	1,200 V						
CKC21C134KDGLC(a)		130 nF	1,000 V						
CKC21C404KWGLC(a)		400 nF	650 V						
CKC21C404KCGLC(a)		400 nF	500 V						
CKC33C303KGGGLC(a)		3640	30 nF	2,000 V	2	Standard	5.10 (0.201) ±0.40 (0.016)		
CKC33C443KJGLC(a)	44 nF		1,700 V						
CKC33C943KEGLC(a)	94 nF		1,200 V	3				Standard Low Loss	Standard: 7.70 (0.303) ±0.60 (0.24) Low Loss: 10.20 (0.402) ±0.40 (0.016)
CKC33C114KDGLC(a)	110 nF		1,000 V						
CKC33C304KWGLC(a)	300 nF		650 V						
CKC33C444KCGLC(a)	440 nF		500 V						
CKC33C453KGGGLC(a)	45 nF		2,000 V	4	Standard Low Loss	Standard: 10.30 (0.405) ±0.80 (0.031) Low Loss: 10.20 (0.402) ±0.40 (0.016)			
CKC33C663KJGLC(a)	66 nF		1,700 V						
CKC33C144KEGLC(a)	140 nF		1,200 V						
CKC33C174KDGLC(a)	170 nF		1,000 V						
CKC33C454KWGLC(a)	450 nF		650 V						
CKC33C664KCGLC(a)	660 nF		500 V						
CKC33C603KGGGLC(a)	60 nF		2,000 V	4	Standard Low Loss	Standard: 10.30 (0.405) ±0.80 (0.031) Low Loss: 10.20 (0.402) ±0.40 (0.016)			
CKC33C883KJGLC(a)	88 nF		1,700 V						
CKC33C194KEGLC(a)	190 nF		1,200 V						
CKC33C204KEGLC(a)	200 nF		1,200 V						
CKC33C224KDGLC(a)	220 nF		1,000 V						
CKC33C604KWGLC(a)	600 nF		650 V						
CKC33C884KCGLC(a)	880 nF		500 V						

¹ Complete part number requires additional characters in the numbered positions provided in order to indicate capacitance tolerance and grade.

For each numbered position, available options are as follows:

(a) Product Grade, Orientation, and Packaging. See Orientation and Packaging (Suffix/C-Spec) Options Table

Table 2 – Performance & Reliability: Test Methods and Conditions

Test	Reference	Test Condition	Limits										
Visual and Mechanical	KEMET Internal	No defects that may affect performance (10X)	Dimensions according KEMET Spec Sheet										
Capacitance (Cap)	KEMET Internal	1 kHz ±50 Hz and 1.0 ±0.2 V _{rms} if capacitance Capacitance measurements (including tolerance) are indexed to a referee time of 1,000 hours	Within Tolerance										
Dissipation Factor (DF)	KEMET Internal	1 kHz ±50 Hz and 1.0 ±0.2 V _{rms}	Dissipation factor (DF) maximum limit at 25°C = 0.1%										
Insulation Resistance (IR)	KEMET Internal	500 VDC applied for 120±5 seconds at 25°C	Within Specification To obtain IR limit, divide MΩ-μF value by the capacitance and compare to GΩ limit. Select the lower of the two limits. 1,000 MΩ-μF or 100 GΩ										
Temperature Coefficient of Capacitance (TCC)	KEMET Internal	Frequency: 1 kHz ±50 Hz Capacitance change with reference to +25°C and 0 VDC applied. * See part number specification sheet for voltage <table border="1" style="margin-left: auto; margin-right: auto;"> <thead> <tr> <th>Step</th> <th>Temperature (°C)</th> </tr> </thead> <tbody> <tr> <td>1</td> <td>+25°C</td> </tr> <tr> <td>2</td> <td>-55°C</td> </tr> <tr> <td>3</td> <td>+25°C (Reference)</td> </tr> <tr> <td>4</td> <td>+150°C</td> </tr> </tbody> </table>	Step	Temperature (°C)	1	+25°C	2	-55°C	3	+25°C (Reference)	4	+150°C	±30 PPM / °C
Step	Temperature (°C)												
1	+25°C												
2	-55°C												
3	+25°C (Reference)												
4	+150°C												
Dielectric Withstanding Voltage (DWV)	KEMET Internal	<table border="1" style="margin-left: auto; margin-right: auto;"> <thead> <tr> <th>Rated DC Voltage</th> <th>DWV Voltage (% of Rated)</th> </tr> </thead> <tbody> <tr> <td>500 V</td> <td>150%</td> </tr> <tr> <td>650 V</td> <td>130%</td> </tr> <tr> <td>≥ 1,000 V</td> <td>120%</td> </tr> </tbody> </table> (5 ±1 seconds and charge/discharge not exceeding 50 mA)	Rated DC Voltage	DWV Voltage (% of Rated)	500 V	150%	650 V	130%	≥ 1,000 V	120%	Cap: Initial Limit DF: Initial Limit IR: Initial Limit Withstand test voltage without insulation breakdown or damage.		
Rated DC Voltage	DWV Voltage (% of Rated)												
500 V	150%												
650 V	130%												
≥ 1,000 V	120%												
Aging Rate (Maximum % Capacitance Loss/Decade Hour)	KEMET Internal	Maximum % capacitance loss/decade hour	0% Loss/Decade Hour										
Terminal Strength	Kemet Internal	Shear stress test per specific case size, Time: 60±1 seconds <table border="1" style="margin-left: auto; margin-right: auto;"> <thead> <tr> <th>Case Size</th> <th>Force</th> </tr> </thead> <tbody> <tr> <td>1812</td> <td rowspan="3">18N</td> </tr> <tr> <td>2220</td> </tr> <tr> <td>3640</td> </tr> </tbody> </table> 	Case Size	Force	1812	18N	2220	3640	No evidence of mechanical damage				
Case Size	Force												
1812	18N												
2220													
3640													

Table 2 – Performance & Reliability: Test Methods and Conditions cont.

Test	Reference	Test Condition	Limits
Board Flex	AEC-Q200-005	Standard Termination system 3.0 mm Test time: 60±5 seconds Ramp time: 1 mm/seconds 	No evidence of mechanical damage
Solderability	J-STD-002	Magnification 10X. Conditions: Category 2 (Dry Bake 155°C / 4 hours ±15 minutes) a) Method B, 245°C, SnPb b) Method B1 at 245°C, Pb-Free c) Method D, at 260°C, SnPb or Pb-Free	Visual Inspection. 95% coverage on termination. No leaching
Temperature Cycling	JESD22 Method JA-104	1,000 cycles (-55°C to +150°C) 2-3 cycles per hour Soak Time 1 or 5 minutes	Measurement at 24 hours ±4 hours after test conclusion. Cap: Initial Limit DF: Initial Limit IR: Initial Limit
Biased Humidity	MIL-STD-202 Method 103	Load Humidity: 1,000 hours 85°C/85% RH and 200 VDC. Add 100 K Ω resistor. Low Volt Humidity: 1,000 hours 85°C/85% RH and 1.5 V. Add 100 K Ω resistor.	Measurement at 24 hours ±4 hours after test conclusion. Within Post Environmental Limits Cap: ±0.3% or ±0.25 pF shift IR: 10% of Initial Limit DF Limits Maximum: 0.5%
Moisture Resistance	MIL-STD-202 Method 106	Number of cycles required 10, 24 hours per cycle. Steps 7a and 7b not required	Measurement at 24 hours ±4 hours after test conclusion. Within Post Environmental Limits Cap: ±0.3% or ±0.25 pF shift IR: 10% of Initial Limit DF Limits Maximum: 0.5%
Thermal Shock	MIL-STD-202 Method 107	Number of cycles required 5, (-55°C to 125°C) Dwell time 15 minutes.	Cap: Initial Limit DF: Initial Limit IR: Initial Limit
High Temperature Life	MIL-STD-202 Method 108	1,000 hours at 150°C with 1.0 X rated voltage applied.	Within Post Environmental Limits Cap: ±0.3% or ±0.25 pF shift IR: 10% of Initial Limit DF Limits Maximum: 0.5%
Storage Life		1,000 hours at 150°C, Unpowered	
Vibration	MIL-STD-202 Method 204	5 g's for 20 minutes, 12 cycles each of 3 orientations. Test from 10 – 2,000 Hz	Cap: Initial Limit DF: Initial Limit IR: Initial Limit
Mechanical Shock	MIL-STD-202 Method 213	1,500 g's 0.5ms Half-sine, Velocity Change 15.4 ft/second (Condition F)	Cap: Initial Limit DF: Initial Limit IR: Initial Limit
Resistance to Solvents	MIL-STD-202 Method 215	Add Aqueous wash chemical OKEMCLEAN (A 6% concentrated Oakite cleaner) or equivalent. Do not use banned solvents	Visual Inspection 10X Readable marking, no decoloration or stains. No physical damage.

Table 3 – KONNEKT Land Pattern Design Recommendations per IPC-7351 (mm)

EIA SIZE CODE	METRIC SIZE CODE	Thickness Code	Median (Nominal) Land Protrusion									
			Standard Orientation					Low Loss Orientation				
			2, 3, & 4-Chip Stack Pad Size					2-Chip Stack Pad Size				
			C	Y	X	V1	V2	C	Y	X	V1	V2
1812	4532	GO	2.05	1.40	3.50	6.00	4.00					
2220	5750	JN	2.65	1.50	5.40	7.30	5.90	2.65	1.50	6.50	7.30	7.00
3640	9210	JF	4.35	1.50	10.60	10.70	11.10					

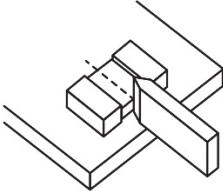
EIA SIZE CODE	METRIC SIZE CODE	Thickness Code	Median (Nominal) Land Protrusion									
			Low Loss Orientation									
			3-Chip Stack Pad Size					4-Chip Stack Pad Size				
			C	Y	X	V1	V2	C	Y	X	V1	V2
1812	4532	GO	2.05	1.40	8.40	6.00	8.90					
2220	5750	JN	2.65	1.50	8.40	7.30	8.90	2.65	1.50	11.20	7.30	11.70
3640	9210	JF	4.35	1.50	8.40	10.70	8.90	4.35	1.50	11.20	10.70	11.70

Soldering Process

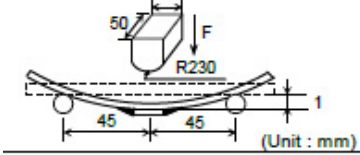
Recommended Reflow Soldering Profile

KEMET's KONNEKT family of high density surface mount multilayer ceramic capacitors (SMD MLCCs) are compatible with convection and IR reflow techniques. Preheating of these components is recommended to avoid extreme thermal stress. KEMET's recommended profile conditions for convection and IR reflow reflect the profile conditions of the IPC/J-STD-020 standard for moisture sensitivity testing. These devices can safely withstand a maximum of three reflow passes at these conditions.

Profile Feature	Termination Finish
	100% matte Sn
Preheat/Soak	
Temperature Minimum (T_{Smin})	150°C
Temperature Maximum (T_{Smax})	200°C
Time (t_s) from T_{Smin} to T_{Smax}	60 – 120 seconds
Ramp-Up Rate (T_L to T_p)	3°C/second maximum
Liquidous Temperature (T_L)	217°C
Time Above Liquidous (t_L)	60 – 150 seconds
Peak Temperature (T_p)	260°C
Time Within 5°C of Maximum Peak Temperature (t_p)	30 seconds maximum
Ramp-Down Rate (T_p to T_L)	6°C/second maximum
Time 25°C to Peak Temperature	8 minutes maximum

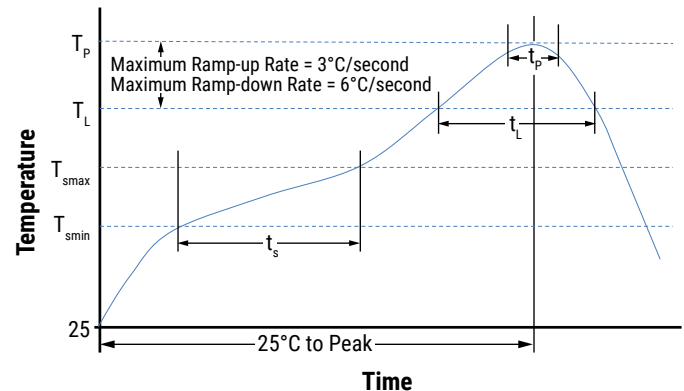

Note: All temperatures refer to the center of the package, measured on the capacitor body surface that is facing up during assembly reflow.

Solder Fillet Height for Low-Loss Orientation

When mounting in low-loss orientation, KEMET recommends a solder fillet height (X) no greater than 1mm and no less than 0.5mm. This ensures the solder contacts and wicks to all the chips in the KONNEKT stack, and ensures all chips are mechanically and electrically connected to the PCB.

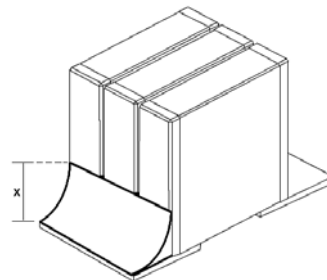

Hand Soldering and Removal of KONNEKT Capacitors

The preferred method of attachment for KEMET's KONNEKT Capacitors is IR or convection reflow where temperature, time and air flow are well controlled.

However, it is understood that the manual attachment of KONNEKT capacitors is necessary for prototype and lab testing. In these instances, care must be taken not to introduce excessive temperature gradients in the KONNEKT part type that may lead to cracking in the ceramic or separation of the TLPS material.

Please see [KEMET's KONNEKT Soldering Guidelines here](#).

Storage & Handling

Ceramic chip capacitors should be stored in normal working environments. While the chips themselves are quite robust in other environments, solderability will be degraded by exposure to high temperatures, high humidity, corrosive atmospheres, and long term storage. In addition, packaging materials will be degraded by high temperature – reels may soften or warp and tape peel force may increase. KEMET recommends that maximum storage temperature not exceed 40°C and maximum storage humidity not exceed 70% relative humidity. In addition, temperature fluctuations should be minimized to avoid condensation on the parts and atmospheres should be free of chlorine and sulfur bearing compounds. For optimized solderability chip stock should be used promptly, preferably within 1.5 years upon receipt.

Construction

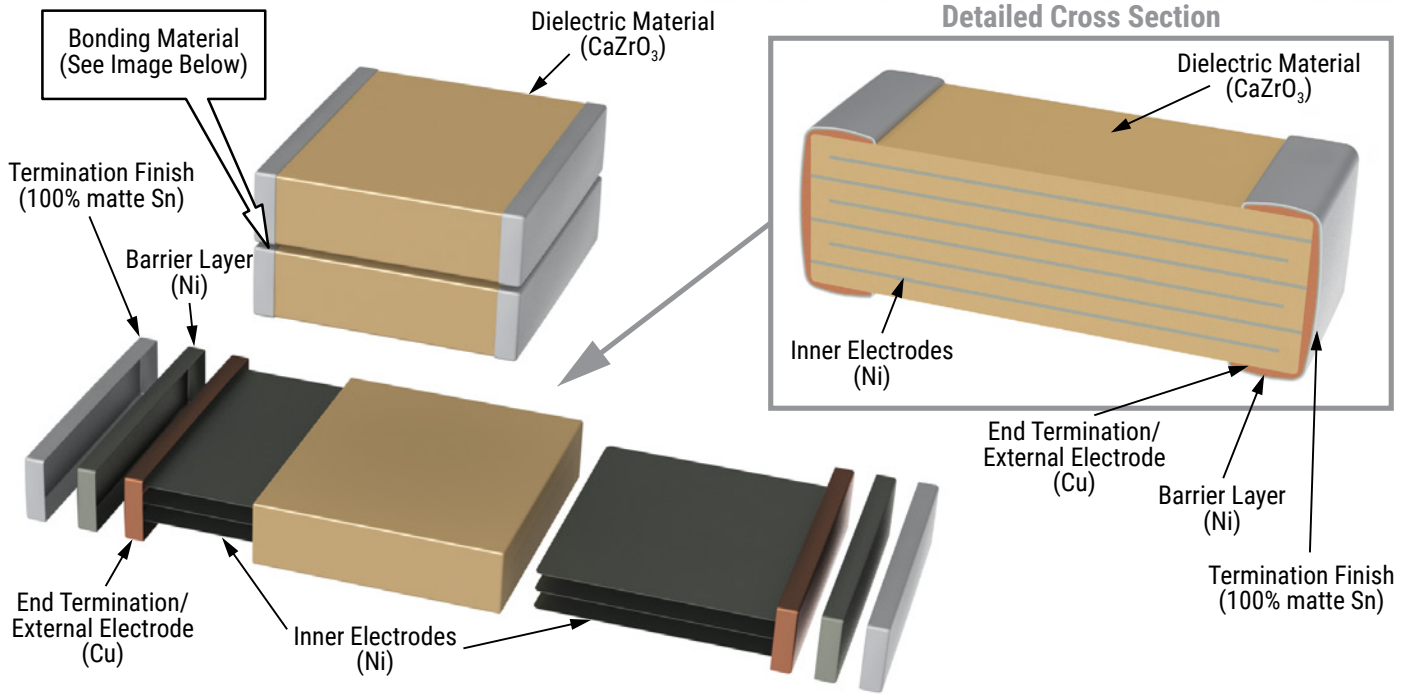

Bonding Material

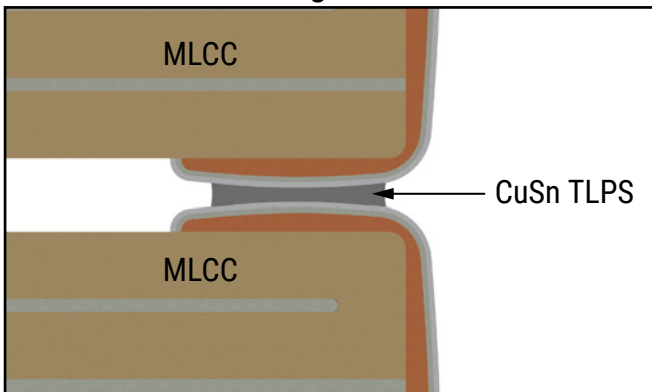

Tape & Reel Packaging Information

KEMET offers multilayer ceramic chip capacitors packaged in 8, 12, 16 and 24 mm tape on 7" and 13" reels in accordance with EIA Standard 481. This packaging system is compatible with all tape-fed automatic pick and place systems. See Table 1B for details on reeling quantities for commercial chips.

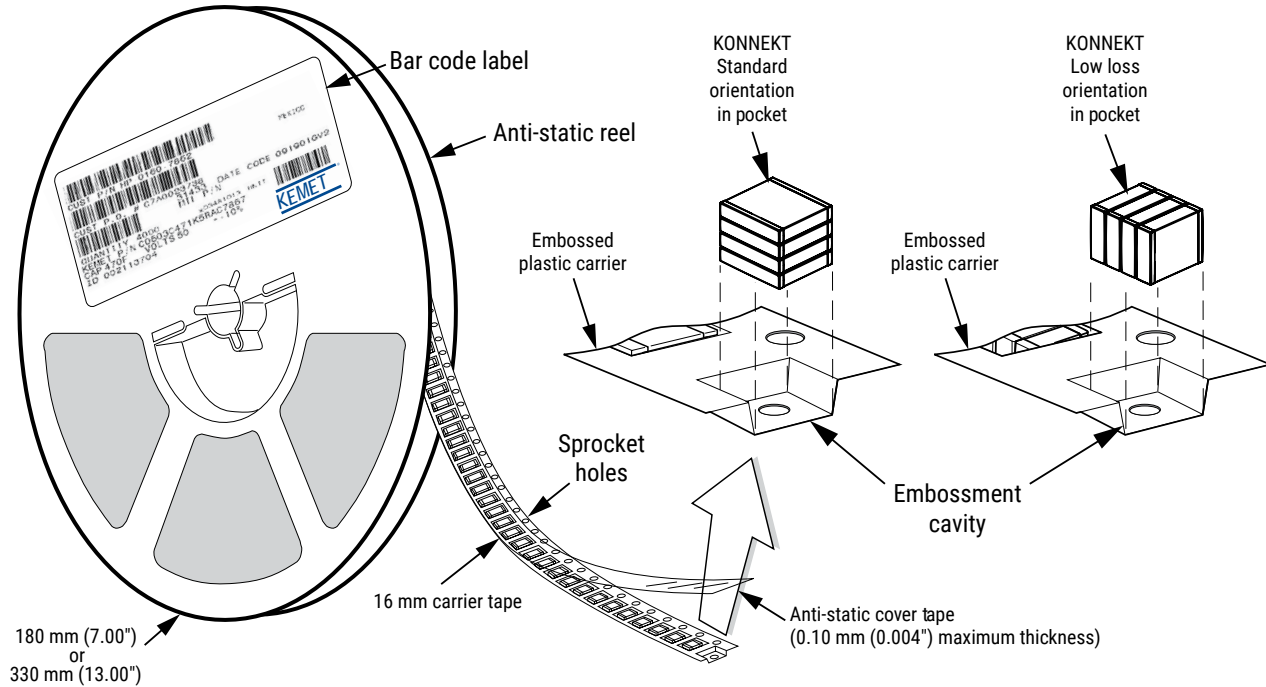

Table 4 – Carrier Tape Configuration, Embossed Plastic (mm)

EIA Case Size	Number of Chips	Part Orientation	Tape Size (W) ¹	Embossed Plastic	
				7" Reel	13" Reel
				Pitch (P ₁) ²	
1812	2	Standard	16	12	12
	3	Standard		16	16
	3	Low Loss		8	8
2220	2	Standard	16	8	8
	2	Low Loss		12	12
	3	Standard		12	12
	3	Low Loss		16	16
	4	Low Loss		20	20
3640	2	Standard	24	20	20
	3	Standard		20	20
	3	Low Loss		20	20
	4	Standard		24	24
	4	Low Loss		24	24

1. Refer to Figures 1 and 2 for W and P1 carrier tape reference locations.
 2. Refer to Tables 4 and 5 for tolerance specifications.

Figure 1 – Embossed (Plastic) Carrier Tape Dimensions

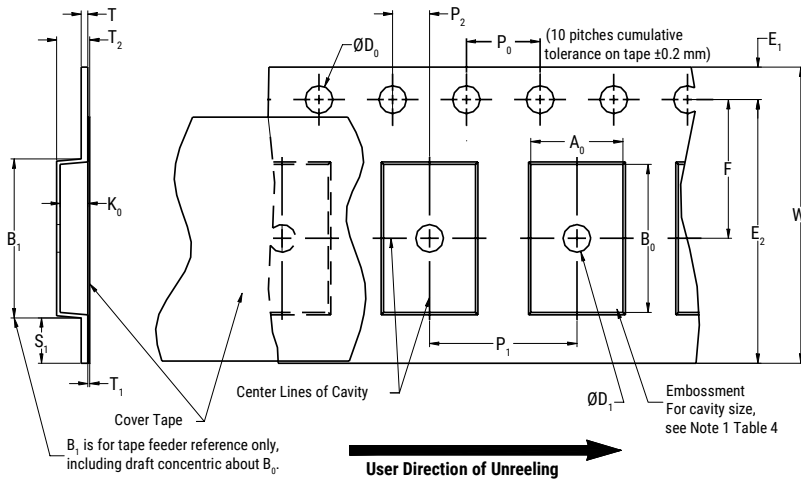

Table 5 – Embossed (Plastic) Carrier Tape Dimensions

Metric will govern

Constant Dimensions – Millimeters (Inches)									
Tape Size	D ₀	D ₁ Minimum Note 1	E ₁	P ₀	P ₂	R Reference Note 2	S ₁ Minimum Note 3	T Maximum	T ₁ Maximum
8 mm 16 mm 24 mm	1.5 +0.10/-0.0 (0.059 +0.004/-0.0)	1.5 (0.059)	1.75±0.10 (0.069±0.004)	4.0±0.10 (0.157±0.004)	2.0±0.05 (0.079±0.002)	30 (1.181)	0.600 (0.024)	0.600 (0.024)	0.100 (0.004)

Variable Dimensions – Millimeters (Inches)								
Tape Size	Pitch	B ₁ Maximum Note 4	E ₂ Minimum	F	P ₁	T ₂ Maximum	W Maximum	A ₀ , B ₀ & K ₀
16 mm	8 mm	9.0 (0.354)	14.25 (0.561)	8.0+/-0.10 (0.315±0.004)	8.0±0.10 (0.315±0.004)	Standard Orientation 1812 & 2220 2 Chip 6.1 (0.240) 3 Chip 8.8 (0.346) 4 Chip 11.4 (0.449) ----- Low Loss Orientation 1812 4.2 (0.166) 2220 6.0 (0.236)	16.3 (0.642)	Note 5
	12 mm				12.0±0.10 (0.472±0.004)			
	16 mm				16.0±0.10 (0.630±0.004)			
	20 mm				20.0±0.10 (0.787±0.004)			
24 mm	20 mm	14.5 (0.571)	22.25 (0.875)	11.5+/-0.10 (0.452±0.004)	20.0±0.10 (0.787±0.004)	3640 11.2 (0.441)	"24.3 (0.957)"	Note 5
	24 mm				24.0±0.10 (0.944±0.004)			

- The embossment hole location shall be measured from the sprocket hole controlling the location of the embossment. Dimensions of embossment location and hole location shall be applied independent of each other.
- The tape with or without components shall pass around R without damage (see Figure 6).
- If S1 < 1.0 mm, there may not be enough area for cover tape to be properly applied (see EIA Document 481 paragraph 4.3 (b)).
- B1 dimension is a reference dimension for tape feeder clearance only.
- The cavity defined by A₀, B₀ and K₀ shall surround the component with sufficient clearance that:
 - the component does not protrude above the top surface of the carrier tape.
 - the component can be removed from the cavity in a vertical direction without mechanical restriction, after the top cover tape has been removed.
 - rotation of the component is limited to 20° maximum for 8 and 12 mm tapes and 10° maximum for 16 mm tapes (see Figure 3).
 - lateral movement of the component is restricted to 0.5 mm maximum for 8 mm and 12 mm wide tape and to 1.0 mm maximum for 16 mm tape (see Figure 4)
 - For KPS Series product, A0 and B0 are measured on a plane 0.3 mm above the bottom of the pocket.

(f) see Addendum in EIA Document 481 for standards relating to more precise taping requirements.

Packaging Information Performance Notes

- Cover Tape Break Force:** 1.0 kg minimum.
- Cover Tape Peel Strength:** The total peel strength of the cover tape from the carrier tape shall be:

Tape Width	Peel Strength
16 mm	0.1 to 1.3 newton (10 to 130 gf)
24 mm	0.1 to 1.6 newton (10 to 160 gf)

The direction of the pull shall be opposite the direction of the carrier tape travel. The pull angle of the carrier tape shall be 165° to 180° from the plane of the carrier tape. During peeling, the carrier and/or cover tape shall be pulled at a velocity of 300±10 mm/minute.

- Labeling:** Bar code labeling (standard or custom) shall be on the side of the reel opposite the sprocket holes. Refer to EIA Standards 556 and 624.

Figure 2 – Maximum Component Rotation

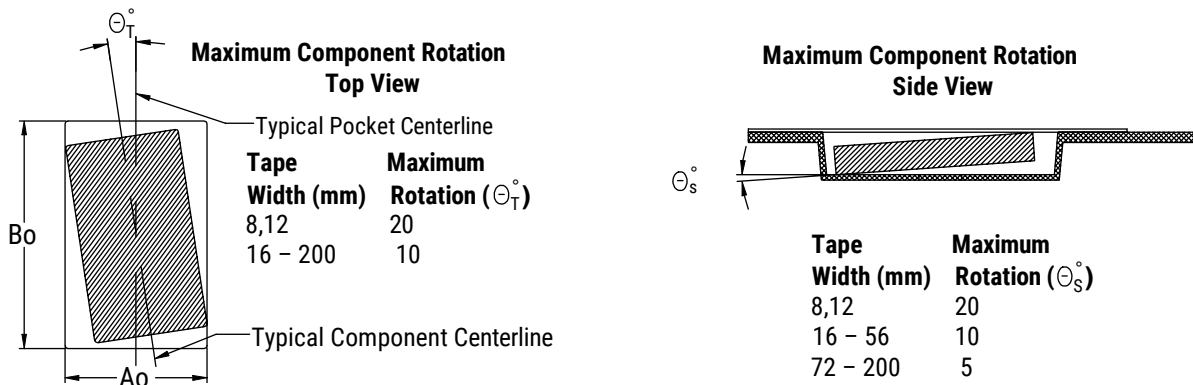

Figure 3 – Maximum Lateral Movement

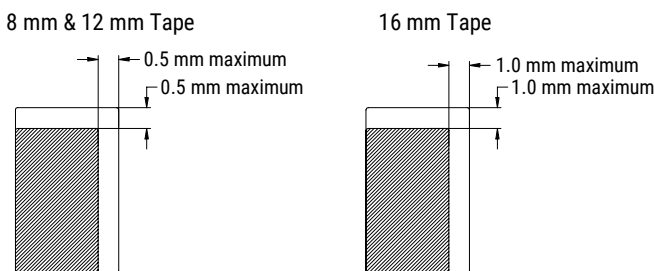

Figure 4 – Bending Radius

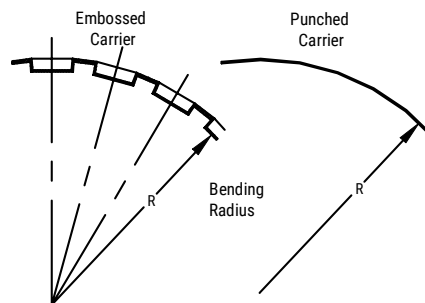
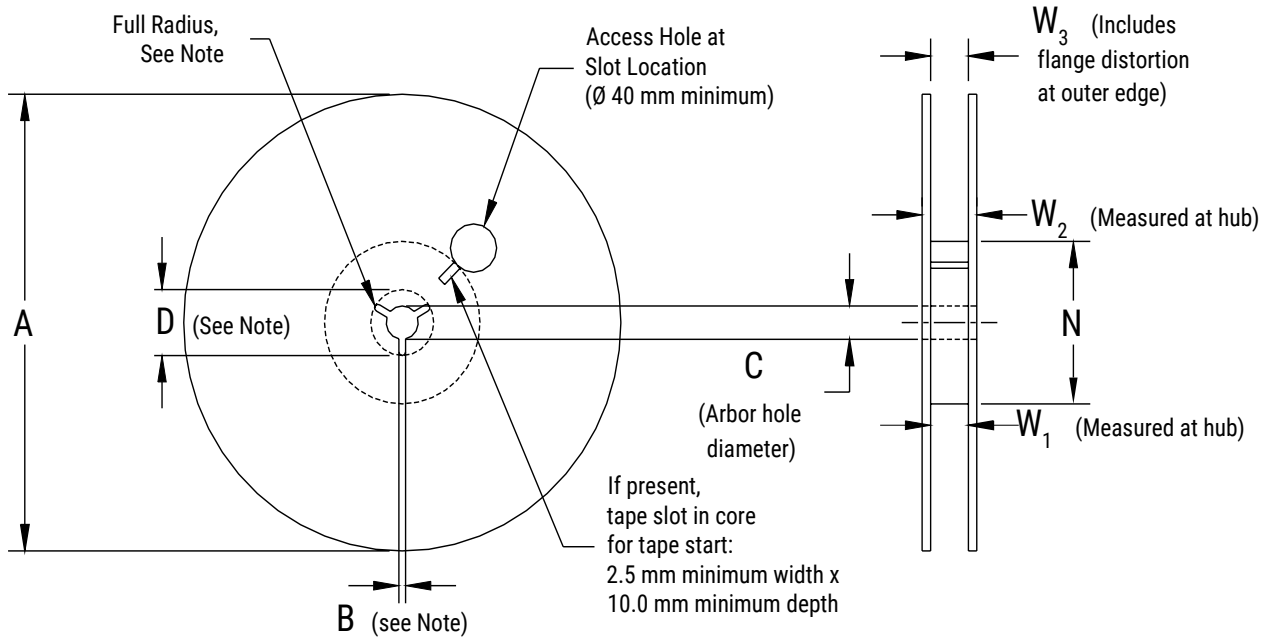

Figure 5 – Reel Dimensions



Note: Drive spokes optional; if used, dimensions B and D shall apply.

Table 6 – Reel Dimensions

Metric will govern

Constant Dimensions – Millimeters (Inches)				
Tape Size	A	B Minimum	C	D Minimum
16 mm	178±0.20 (7.008±0.008)	1.5 (0.059)	13.0+0.5/-0.2 (0.521+0.02/-0.008)	20.2 (0.795)
24 mm	330±0.20 (13.000±0.008)			
Variable Dimensions – Millimeters (Inches)				
Tape Size	N Minimum See Note 2, Tables 2-3	W ₁	W ₂ Maximum	W ₃
16 mm	50 (1.969)	16.4+2.0/-0.0 (0.646+0.078/-0.0)	22.4 (0.882)	Shall accommodate tape width without interference
24 mm	50 (1.969)	25+1.0/-0.0 (0.984+0.039/-0.0)	27.4+1.0/-1.0 (1.078+0.039/-0.039)	

Figure 6 – Tape Leader & Trailer Dimensions

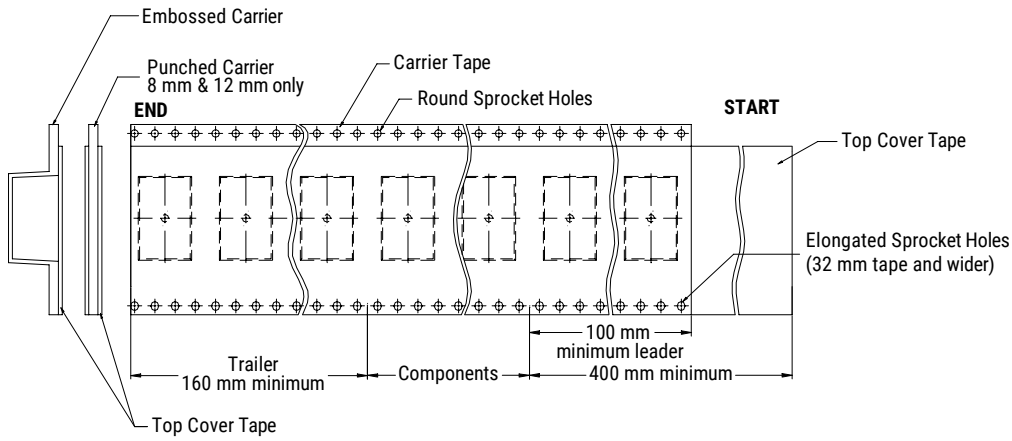
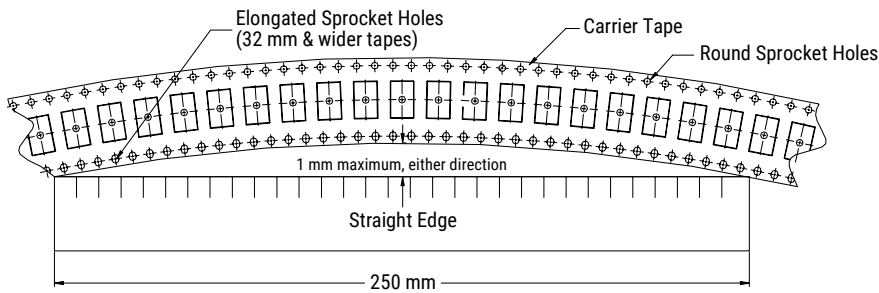

Figure 7 – Maximum Camber



KEMET Electronics Corporation Sales Offices

For a complete list of our global sales offices, please visit www.kemet.com/sales.

Disclaimer

YAGEO Corporation and its affiliates do not recommend the use of commercial or automotive grade products for high reliability applications or manned space flight.

All product specifications, statements, information and data (collectively, the "Information") in this datasheet are subject to change. The customer is responsible for checking and verifying the extent to which the Information contained in this publication is applicable to an order at the time the order is placed. All Information given herein is believed to be accurate and reliable, but it is presented without guarantee, warranty, or responsibility of any kind, expressed or implied.

Statements of suitability for certain applications are based on KEMET Electronics Corporation's ("KEMET") knowledge of typical operating conditions for such applications, but are not intended to constitute – and KEMET specifically disclaims – any warranty concerning suitability for a specific customer application or use. The Information is intended for use only by customers who have the requisite experience and capability to determine the correct products for their application. Any technical advice inferred from this Information or otherwise provided by KEMET with reference to the use of KEMET's products is given gratis, and KEMET assumes no obligation or liability for the advice given or results obtained.

Although KEMET designs and manufactures its products to the most stringent quality and safety standards, given the current state of the art, isolated component failures may still occur. Accordingly, customer applications which require a high degree of reliability or safety should employ suitable designs or other safeguards (such as installation of protective circuitry or redundancies) in order to ensure that the failure of an electrical component does not result in a risk of personal injury or property damage.

Although all product-related warnings, cautions and notes must be observed, the customer should not assume that all safety measures are indicated or that other measures may not be required.

KEMET is a registered trademark of KEMET Electronics Corporation.