



## Overview

KEMET's COG with KONNEKT™ technology surface mount capacitors are designed for high-efficiency and high-density power applications. KONNEKT high density packaging technology uses an innovative Transient Liquid Phase Sintering (TLPS) material to create a surface mount multi-chip solution for high density packaging. By utilizing KEMET's robust and proprietary COG base metal electrode (BME) dielectric system, these capacitors are well suited for power converters, inverters, snubbers, and resonators where high efficiency is a primary concern.

With an operating temperature range up to 125°C, these capacitors can be mounted close to fast switching semiconductors in high power density applications, which require minimal cooling. COG with KONNEKT technology also exhibits high mechanical robustness compared to other dielectric technologies, allowing the capacitor to be mounted without the use of metal frames.

COG with KONNEKT series compliments the KC-LINK with KONNEKT series by offering a wider voltage range and operating temperature range up to 125°C

## Benefits

- Extremely high-power density and ripple current capability
- Extremely low equivalent series resistance (ESR)
- Extremely low equivalent series inductance (ESL)
- Capacitance offerings ranging from 0.78 nF – 2.0 µF
- DC voltage ratings from 10 – 3,000 V
- EIA sizes 1206, 1210, 1812 and 2220
- Operating temperature range of -55°C to +125°C
- No capacitance shift with voltage
- No piezoelectric noise
- High thermal stability
- Surface mountable using standard MLCC reflow profiles

## Applications

- Wide bandgap (WBG), silicon carbide (SiC) and gallium nitride (GaN) systems
- Data centers
- EV/HEV (drive systems, charging)
- LLC resonant converters
- Switched tank converters
- Wireless charging systems
- Photovoltaic systems
- Power converters
- Inverters
- DC link
- Snubber

Standard



Low Loss







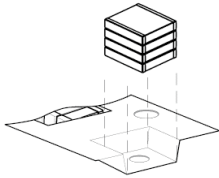

## Ordering Information

C	1812	C	943	K	C	G	L	C	XXXX
Ceramic	Case Size (L"x W")	Specification/ Series	Capacitance Code (pF)	Capacitance Tolerance	Rated Voltage (V)	Dielectric	Subclass Designation	Termination Finish	Orientation and Packaging (Suffix/C-Spec)
C	1206 1210 1812 2220	C = Standard	Two single digits + number of zeros.	K = ±10%	8 = 10 V 4 = 16 V 3 = 25 V 5 = 50 V 1 = 100 V 2 = 200 V A = 250 V C = 500 V B = 630 V D = 1,000 V F = 1,500 V G = 2,000 V Z = 2,500 V H = 3,000 V	G = COG	L = KONNEKT	C = 100% matte Sn	See "Packaging and Orientation C-Spec Ordering Options Table"

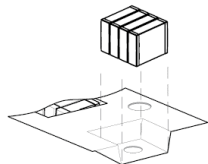
*Additional termination finish options may be available. Contact KEMET for details.*

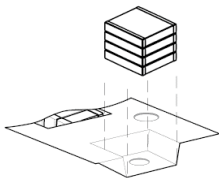
## Orientation and Packaging (Suffix/C-Spec) Options Table

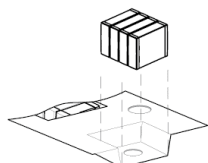
Mounting Orientation <sup>1</sup>	Tape and Reel Illustration	Packaging Type	Packaging/Grade Ordering Code (C-Spec)
<b>Commercial Grade</b>			
Standard 		7" Reel/Unmarked	TU
		13" Reel/Unmarked	7210
Low Loss 		7" Reel/Unmarked	7805
		13" Reel/Unmarked	7810
<b>Automotive Grade</b>			
Standard 		7" Reel/Unmarked	AUTO
		13" Reel/Unmarked	AUTO7210
Low Loss 		7" Reel/Unmarked	AUTO7805
		13" Reel/Unmarked	AUTO7810

<sup>1</sup> - Orientation refers to the positioning of the KONNEKT capacitors in the Tape and Reel pockets. This allows pick and place machines to place capacitors on the PCB in the correct orientation.

## Automotive C-Spec Information

KEMET automotive grade products meet or exceed the requirements outlined by the Automotive Electronics Council. Details regarding test methods and conditions are referenced in document AEC-Q200, Stress Test Qualification for Passive Components. These products are supported by a Product Change Notification (PCN) and Production Part Approval Process warrant (PPAP).

Automotive products offered through our distribution channel have been assigned an inclusive ordering code C-Spec, "AUTO." This C-Spec was developed in order to better serve small and medium-sized companies that prefer an automotive grade component without the requirement to submit a customer Source Controlled Drawing (SCD) or specification for review by a KEMET engineering specialist. This C-Spec is therefore not intended for use by KEMET OEM automotive customers and are not granted the same "privileges" as other automotive C-Specs. Customer PCN approval and PPAP request levels are limited (see details below.)

### Product Change Notification (PCN)

The KEMET product change notification system is used to communicate primarily the following types of changes:

- Product/process changes that affect product form, fit, function, and/or reliability
- Changes in manufacturing site
- Product obsolescence

KEMET Automotive C-Spec	Customer Notification Due To:		Days Prior To Implementation
	Process/Product change	Obsolescence*	
KEMET assigned <sup>1</sup>	Yes (with approval and sign off)	Yes	180 days minimum
AUTO	Yes (without approval)	Yes	90 days minimum

<sup>1</sup> KEMET assigned C-Specs require the submittal of a customer SCD or customer specification for review. For additional information contact KEMET.

### Production Part Approval Process (PPAP)

The purpose of the Production Part Approval Process is:

- To ensure that supplier can meet the manufacturability and quality requirements for the purchased parts.
- To provide the evidence that all customer engineering design records and specification requirements are properly understood and fulfilled by the manufacturing organization.
- To demonstrate that the established manufacturing process has the potential to produce the part.

KEMET Automotive C-Spec	PPAP (Product Part Approval Process) Level				
	1	2	3	4	5
KEMET assigned <sup>1</sup>	•	•	•	•	•
AUTO			○		

<sup>1</sup> KEMET assigned C-Specs require the submittal of a customer SCD or customer specification for review. For additional information contact KEMET.

- Part number specific PPAP available
- Product family PPAP only

## Dimensions – Millimeters (Inches)

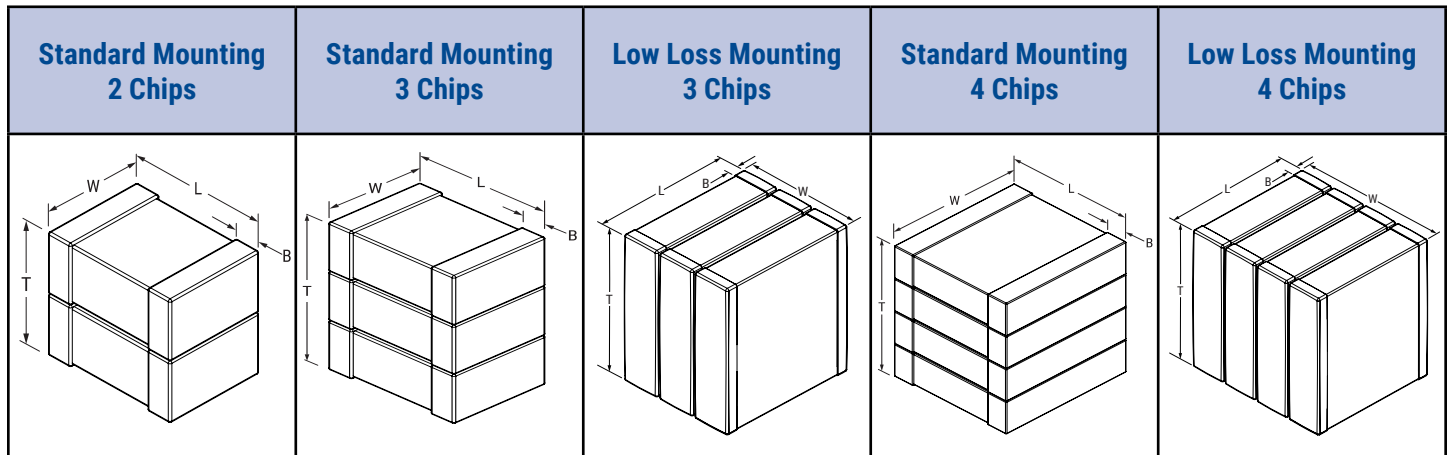

EIA SIZE CODE	METRIC SIZE CODE	Number of Chips	Mounting	L LENGTH	W WIDTH	T THICKNESS	B BANDWIDTH	Mounting Technique
1206	3216	2	Standard	3.20 (0.126) ±0.20 (0.008)	1.60 (0.063) ±0.20 (0.008)	See Ordering Code Table	0.50 (0.02) ±0.25 (0.010)	Solder Reflow Only
1210	3225	2	Standard	3.20 (0.126) ±0.20 (0.008)	2.50 (0.098) ±0.20 (0.008)			
1812	4532	2	Standard	4.50 (0.177) ±0.30 (0.012)	3.20 (0.126) ±0.30 (0.012)	0.60 (0.024) ±0.35 (0.014)		
		3	Standard		3.20 (0.126) ±0.30 (0.012)			
Low Loss	7.70 (0.303) ±0.60 (0.24)							
2220	5750	2	Standard	5.70 (0.224) ±0.40 (0.016)	5.00 (0.197) ±0.40 (0.016)			
		3	Standard		5.00 (0.197) ±0.40 (0.016)			
			Low Loss		7.70 (0.303) ±0.60 (0.24)			
		4	Low Loss		10.30 (0.405) ±0.80 (0.031)			

**Table 1A - 1206, 2-Chip Product Ordering Codes, Ratings, and Package Quantities**

KEMET Part Number	Capacitance	Cap Code	Voltage	Number of Chips	Orientation Available	Thickness mm (inch)	Typical Average Piece Weight (g)	Tape & Reel Quantity	
								7" Tape & Reel	13" Tape & Reel
C1206C204K8GLC(a)	200 nF	204	10 V	2	Standard	3.2 (0.126) ± 0.4 (0.016)	0.08	500	1900
C1206C204K4GLC(a)	200 nF	204	16 V			3.2 (0.126) ± 0.4 (0.016)	0.08	500	1900
C1206C204K3GLC(a)	200 nF	204	25 V			3.2 (0.126) ± 0.4 (0.016)	0.08	500	1900
C1206C164K5GLC(a)	160 nF	164	50 V			3.2 (0.126) ± 0.4 (0.016)	0.08	500	1900
C1206C943K1GLC(a)	94 nF	943	100 V			3.2 (0.126) ± 0.4 (0.016)	0.08	500	1900
C1206C443K2GLC(a)	44 nF	443	200 V			3.2 (0.126) ± 0.4 (0.016)	0.08	500	1900
C1206C443KAGLC(a)	44 nF	443	250 V			3.2 (0.126) ± 0.4 (0.016)	0.08	500	1900
C1206C303KCGLC(a)	30 nF	303	500 V			3.2 (0.126) ± 0.4 (0.016)	0.08	500	1900
C1206C203KBGLC(a)	20 nF	203	630 V			3.3 (0.130) ± 0.4 (0.016)	0.08	500	1900
C1206C542KDGLC(a)	5.4 nF	542	1000 V			3.3 (0.130) ± 0.4 (0.016)	0.08	500	1900
C1206C112KFGLC(a)	1.1 nF	112	1500 V			3.3 (0.130) ± 0.4 (0.016)	0.08	500	1900
C1206C541KGGGLC(a)	5.4 nF	541	2000 V			3.3 (0.130) ± 0.4 (0.016)	0.08	500	1900

(a) C-Spec for Product Grade, Reeling and Mounting Orientation.

**Table 1B - 1210, 2-Chip Product Ordering Codes, Ratings, and Package Quantities**

KEMET Part Number	Capacitance	Cap Code	Voltage	Number of Chips	Orientation Available	Thickness mm (inch)	Typical Average Piece Weight (g)	Tape & Reel Quantity	
								7" Tape & Reel	13" Tape & Reel
C1210C444K8GLC(a)	440 nF	444	10 V	2	Standard	4.3 (0.169) ± 0.4 (0.016)	0.17	375	1500
C1210C444K4GLC(a)	440 nF	444	16 V			4.3 (0.169) ± 0.4 (0.016)	0.17	375	1500
C1210C444K3GLC(a)	440 nF	444	25 V			4.3 (0.169) ± 0.4 (0.016)	0.17	375	1500
C1210C304K5GLC(a)	300 nF	304	50 V			3.4 (0.134) ± 0.4 (0.016)	0.15	450	1800
C1210C204K1GLC(a)	200 nF	204	100 V			3.4 (0.134) ± 0.4 (0.016)	0.15	450	1800
C1210C943K2GLC(a)	94 nF	943	200 V			3.6 (0.142) ± 0.4 (0.016)	0.15	425	1750
C1210C943KAGLC(a)	94 nF	943	250 V			3.6 (0.142) ± 0.4 (0.016)	0.15	425	1750
C1210C663KCGLC(a)	66 nF	663	500 V			5.3 (0.209) ± 0.4 (0.016)	0.20	200	800
C1210C663KBGLC(a)	66 nF	663	630 V			5.3 (0.209) ± 0.4 (0.016)	0.20	200	800
C1210C443KDGLC(a)	44 nF	443	1000 V			5.3 (0.209) ± 0.4 (0.016)	0.20	200	800
C1210C242KFGLC(a)	2.4 nF	242	1500 V			5.1 (0.201) ± 0.4 (0.016)	0.20	300	1250
C1210C142KGGLC(a)	1.4 nF	142	2000 V			5.1 (0.201) ± 0.4 (0.016)	0.20	300	1250

(a) C-Spec for Product Grade, Reeling and Mounting Orientation.

**Table 1C - 1812, 2-Chip Product Ordering Codes, Ratings, and Package Quantities**

KEMET Part Number	Capacitance	Cap Code	Voltage	Number of Chips	Orientation Available	Thickness mm (inch)	Typical Average Piece Weight (g)	Tape & Reel Quantity	
								7" Tape & Reel	13" Tape & Reel
C1812C444K5GLC(a)	440 nF	444	50 V	2	Standard	3.3 (0.130) ± 0.4 (0.016)	0.19	500	2000
C1812C304K1GLC(a)	300 nF	304	100 V			3.5 (0.138) ± 0.4 (0.016)	0.19	500	2000
C1812C204K2GLC(a)	200 nF	204	200 V			4.1 (0.161) ± 0.4 (0.016)	0.24	275	1050
C1812C204KAGLC(a)	200 nF	204	250 V			4.1 (0.161) ± 0.4 (0.016)	0.24	275	1050
C1812C943KCGLC(a)	94 nF	943	500 V			5.1 (0.200) ± 0.4 (0.016)	0.3	200	850
C1812C943KBGLC(a)	94 nF	943	630 V				0.3	200	850
C1812C303KDGLC(a)	30 nF	303	1000 V				0.3	200	850
C1812C542KFGLC(a)	5.4 nF	542	1500 V				0.3	200	850
C1812C302KGGLC(a)	3 nF	302	2000 V				0.3	200	850
C1812C142KZGLC(a)	1.4 nF	142	2500 V				0.3	200	850
C1812C781KHGLC(a)	0.78 nF	781	3000 V				0.3	200	850

(a) C-Spec for Product Grade, Reeling and Mounting Orientation.



**Table 1D - 1812, 3-Chip Product Ordering Codes, Ratings, and Package Quantities**

KEMET Part Number	Capacitance	Cap Code	Voltage	Number of Chips	Orientation Available	Thickness mm (inch)	Typical Average Piece Weight (g)	Tape & Reel Quantity		
								7" Tape & Reel	13" Tape & Reel	
C1812C664K5GLC(a)	660 nF	664	50 V	3	Standard	5.0 (0.197) ± 0.6 (0.024)	0.28	200	950	
C1812C454K1GLC(a)	450 nF	454	100 V			5.3 (0.209) ± 0.6 (0.024)	0.28	200	900	
C1812C304K2GLC(a)	300 nF	304	200 V			6.2 (0.244) ± 0.6 (0.024)	0.36	175	725	
C1812C304KAGLC(a)	300 nF	304	250 V			6.2 (0.244) ± 0.6 (0.024)	0.36	175	725	
C1812C144KCGLC(a)	140 nF	144	500 V			Low Loss	7.7 (0.303) ± 0.6 (0.024)	0.45	100	600
C1812C144KBGLC(a)	140 nF	144	630 V					0.45	100	600
C1812C453KDGLC(a)	45 nF	453	1000 V					0.45	100	600
C1812C802KFGLC(a)	8 nF	802	1500 V					0.45	100	600
C1812C452KGGLC(a)	4.5 nF	452	2000 V					0.45	100	600
C1812C202KZGLC(a)	2.0 nF	202	2500 V					0.45	100	600
C1812C122KHGLC(a)	1.2 nF	122	3000 V		0.45			100	600	
C1812C664K5GLC(a)	660 nF	664	50 V		5.0 (0.197) ± 0.6 (0.024)			0.28	500	2200
C1812C454K1GLC(a)	450 nF	454	100 V		5.3 (0.209) ± 0.6 (0.024)			0.28	500	2200
C1812C304K2GLC(a)	300 nF	304	200 V		6.2 (0.244) ± 0.6 (0.024)			0.36	350	1350
C1812C304KAGLC(a)	300 nF	304	250 V		6.2 (0.244) ± 0.6 (0.024)	0.36	350	1350		
C1812C144KCGLC(a)	140 nF	144	500 V		7.7 (0.303) ± 0.6 (0.024)	0.45	350	1350		
C1812C144KBGLC(a)	140 nF	144	630 V			0.45	350	1350		
C1812C453KDGLC(a)	45 nF	453	1000 V			0.45	350	1350		
C1812C802KFGLC(a)	8 nF	802	1500 V			0.45	350	1350		
C1812C452KGGLC(a)	4.5 nF	452	2000 V			0.45	350	1350		
C1812C202KZGLC(a)	2.0 nF	202	2500 V	0.45		350	1350			
C1812C122KHGLC(a)	1.2 nF	122	3000 V	0.45		350	1350			

(a) C-Spec for Product Grade, Reeling and Mounting Orientation.

**Table 1E - 2220, 2-Chip Product Ordering Codes, Ratings, and Package Quantities**

KEMET Part Number	Capacitance	Cap Code	Voltage	Number of Chips	Orientation Available	Thickness mm (inch)	Typical Average Piece Weight (g)	Tape & Reel Quantity	
								7" Tape & Reel	13" Tape & Reel
C2220C944K5GLC(a)	940 nF	944	50 V	2	Standard	3.5 (0.138) ± 0.4 (0.016)	0.45	475	1825
C2220C664K1GLC(a)	660 nF	664	100 V			3.5 (0.138) ± 0.4 (0.016)	0.445	475	1825
C2220C444K2GLC(a)	440 nF	444	200 V			4.1 (0.161) ± 0.4 (0.016)	0.45	225	950
C2220C204KCGLC(a)	200 nF	204	500 V			5.1 (0.200) ± 0.4 (0.016)	0.65	300	1250
C2220C204KBGLC(a)	200 nF	204	630 V				0.65	300	1250
C2220C663KDGLC(a)	66 nF	663	1000 V				0.65	300	1250
C2220C143KFGLC(a)	14 nF	143	1500 V				0.65	300	1250
C2220C782KGGLC(a)	7.8 nF	782	2000 V				0.645	300	1250
C2220C362KZGLC(a)	3.6 nF	362	2500 V				0.65	300	1250
C2220C202KHGLC(a)	2.0 nF	202	3000 V				0.65	300	1250

(a) C-Spec for Product Grade, Reeling and Mounting Orientation.

**Table 1F - 2220, 3-Chip Product Ordering Codes, Ratings, and Package Quantities**

KEMET Part Number	Capacitance	Cap Code	Voltage	Number of Chips	Orientation Available	Thickness mm (inch)	Typical Average Piece Weight (g)	Tape & Reel Quantity	
								7" Tape & Reel	13" Tape & Reel
C2220C145K5GLC(a)	1.4 uF	145	50 V	3	Standard	5.3 (0.209) ± 0.45 (0.018)	0.67	300	1250
C2220C105K1GLC(a)	1.0 uF	105	100 V			5.3 (0.209) ± 0.45 (0.018)	0.67	300	1250
C2220C664K2GLC(a)	660 nF	664	200 V			6.2 (0.244) ± 0.6 (0.024)	0.67	175	700
C2220C304KCGLC(a)	300 nF	304	500 V			7.7 (0.303) ± 0.6 (0.024)	0.97	125	575
C2220C304KBGLC(a)	300 nF	304	630 V				0.97	125	575
C2220C104KDGLC(a)	100 nF	104	1000 V				0.97	125	575
C2220C203KFGLC(a)	20 nF	203	1500 V				0.97	125	575
C2220C123KGGLC(a)	12 nF	123	2000 V				0.97	125	575
C2220C542KZGLC(a)	5.4 nF	542	2500 V				0.97	125	575
C2220C302KHGLC(a)	3 nF	302	3000 V				0.97	125	575
C2220C145K5GLC(a)	1.4 uF	145	50 V		Low Loss		5.3 (0.209) ± 0.45 (0.018)	0.67	225
C2220C105K1GLC(a)	1.0 uF	105	100 V			5.3 (0.209) ± 0.45 (0.018)	0.67	225	900
C2220C664K2GLC(a)	660 nF	664	200 V			6.2 (0.244) ± 0.6 (0.024)	0.67	225	900
C2220C304KCGLC(a)	300 nF	304	500 V			7.7 (0.303) ± 0.6 (0.024)	0.97	160	675
C2220C304KBGLC(a)	300 nF	304	630 V				0.97	160	675
C2220C104KDGLC(a)	100 nF	104	1000 V				0.97	160	675
C2220C203KFGLC(a)	20 nF	203	1500 V				0.97	160	675
C2220C123KGGLC(a)	12 nF	123	2000 V				0.97	160	675
C2220C542KZGLC(a)	5.4 nF	542	2500 V				0.97	160	675
C2220C302KHGLC(a)	3 nF	302	3000 V			0.97	160	675	

(a) C-Spec for Product Grade, Reeling and Mounting Orientation.

**Table 1G - 2220, 4-Chip Product Ordering Codes, Ratings, and Package Quantities**

KEMET Part Number	Capacitance	Cap Code	Voltage	Number of Chips	Orientation Available	Thickness mm (inch)	Typical Average Piece Weight (g)	Tape & Reel Quantity	
								7" Tape & Reel	13" Tape & Reel
C2220C205K5GLC(a)	2uF	205	50 V	4	Low Loss	7.1 (0.280) ± 0.6 (0.024)	0.9	125	525
C2220C135K1GLC(a)	1.3 uF	135	100 V			7.1 (0.280) ± 0.6 (0.024)	0.9	125	525
C2220C884K2GLC(a)	880 nF	884	200 V			8.3 (0.327) ± 0.6 (0.024)	0.9	125	525
C2220C404KCGLC(a)	400 nF	404	500 V			10.3 (0.406) ± 0.8 (0.031)	1.3	125	525
C2220C404KBGLC(a)	400 nF	404	630 V				1.3	125	525
C2220C134KDGLC(a)	130 nF	134	1000 V				1.3	125	525
C2220C273KFGLC(a)	27 nF	273	1500 V				1.3	125	525
C2220C163KGGLC(a)	16 nF	163	2000 V				1.3	125	525
C2220C722KZGLC(a)	7.2 nF	722	2500 V				1.3	125	525
C2220C402KHGLC(a)	4 nF	402	3000 V			1.3	125	525	

(a) C-Spec for Product Grade, Reeling and Mounting Orientation.

**Table 2 - Performance and Reliability: Test Methods and Conditions (Commercial Only)**

Test	Reference	Test Condition	Limits										
Visual and Mechanical	KEMET Internal	No defects that may affect performance (10X)	Dimensions according KEMET Spec Sheet										
Capacitance (Cap)	KEMET Internal	1 kHz $\pm$ 50 Hz and 1.0 $\pm$ 0.2 V <sub>rms</sub> of capacitance Capacitance measurements (including tolerance) are indexed to a referee time of 1,000 hours	Within Tolerance										
Dissipation Factor (DF)	KEMET Internal	1 kHz $\pm$ 50 Hz and 1.0 $\pm$ 0.2 V <sub>rms</sub>	Dissipation factor (DF) maximum limit at 25°C = 0.1%										
Insulation Resistance (IR)	KEMET Internal	For < 500 VDC: Rated voltage applied for 120 $\pm$ 5 seconds at 25°C  For $\geq$ 500 VDC: 500 V applied for 120 $\pm$ 5 seconds at 25°C	Within Specification  To obtain IR limit, divide M $\Omega$ - $\mu$ F value by the capacitance and compare to G $\Omega$ limit. Select the lower of the two limits.  1,000 M $\Omega$ - $\mu$ F or 100 G $\Omega$										
Temperature Coefficient of Capacitance (TCC)	KEMET Internal	Frequency: 1 kHz $\pm$ 50 Hz Capacitance change with reference to +25°C and 0 VDC applied  * See part number specification sheet for voltage  <table border="1" style="margin-left: auto; margin-right: auto;"> <thead> <tr> <th>Step</th> <th>Temperature (°C)</th> </tr> </thead> <tbody> <tr> <td>1</td> <td>+25°C</td> </tr> <tr> <td>2</td> <td>-55°C</td> </tr> <tr> <td>3</td> <td>+25°C (Reference Temperature)</td> </tr> <tr> <td>4</td> <td>+125°C</td> </tr> </tbody> </table>	Step	Temperature (°C)	1	+25°C	2	-55°C	3	+25°C (Reference Temperature)	4	+125°C	$\pm$ 30 PPM/°C
Step	Temperature (°C)												
1	+25°C												
2	-55°C												
3	+25°C (Reference Temperature)												
4	+125°C												
Dielectric Withstanding Voltage (DWV)	KEMET Internal	<table border="1" style="margin-left: auto; margin-right: auto;"> <thead> <tr> <th>Rated DC Voltage</th> <th>DWV Voltage (% of Rated)</th> </tr> </thead> <tbody> <tr> <td>&lt; 500</td> <td>250%</td> </tr> <tr> <td>500</td> <td>150%</td> </tr> <tr> <td>630</td> <td>130%</td> </tr> <tr> <td><math>\geq</math> 1,000</td> <td>120%</td> </tr> </tbody> </table> (5 $\pm$ 1 seconds and charge/discharge not exceeding 50 mA)	Rated DC Voltage	DWV Voltage (% of Rated)	< 500	250%	500	150%	630	130%	$\geq$ 1,000	120%	Withstand test voltage without insulation breakdown or damage.
Rated DC Voltage	DWV Voltage (% of Rated)												
< 500	250%												
500	150%												
630	130%												
$\geq$ 1,000	120%												
Aging Rate (Maximum % Capacitance Loss/Decade Hour)	KEMET Internal	Maximum % capacitance loss/decade hour	0% Loss/Decade Hour										

**Table 2 - Performance and Reliability: Test Methods and Conditions (Commercial Only) cont.**

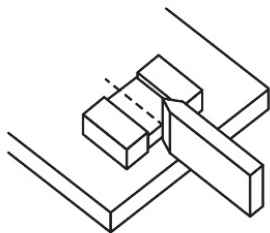
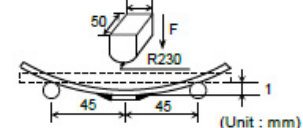
Test	Reference	Test Condition	Limits							
Terminal Strength	KEMET Internal	Shear stress test per specific case size, Time: 60±1 seconds  <table border="1"> <thead> <tr> <th>Case Size</th> <th>Force</th> </tr> </thead> <tbody> <tr> <td>1206</td> <td rowspan="4">18N</td> </tr> <tr> <td>1210</td> </tr> <tr> <td>1812</td> </tr> <tr> <td>2220</td> </tr> </tbody> </table> 	Case Size	Force	1206	18N	1210	1812	2220	No evidence of mechanical damage
Case Size	Force									
1206	18N									
1210										
1812										
2220										
Board Flex	AEC-Q200-005	Standard Termination System 3.0 mm Test time: 60± 5 seconds Ramp time: 1 mm/second  	No evidence of mechanical damage							
Temperature Cycling	JESD22 Method JA-104	1,000 cycles (-55°C to +125°C) 2 – 3 cycles per hour Soak Time 1 or 5 minutes	Measurement at 24 hours ±4 hours after test conclusion. Cap: ±0.3% or ±0.25 pF shift DF: Initial Limit IR: Initial Limit							
Biased Humidity	MIL-STD-202 Method 103	Load Humidity: 1,000 hours 85°C/85% RH and 200 VDC. Add 100 KΩ resistor.  Low Volt Humidity: 1,000 hours 85°C/85% RH and 1.5 V. Add 100 KΩ resistor.	Measurement at 24 hours ±4 hours after test conclusion. Within Post Environmental Limits Cap: ±0.3% or ±0.25 pF shift IR: 10% of Initial Limit DF Limits Maximum: 0.5%							
Moisture Resistance	MIL-STD-202 Method 106	Number of cycles required 10, 24 hours per cycle. Steps 7a and 7b not required.	Measurement at 24 hours ±4 hours after test conclusion. Within Post Environmental Limits Cap: ±0.3% or ±0.25 pF shift IR: 10% of Initial Limit DF Limits Maximum: 0.5%							

**Table 2 - Performance and Reliability: Test Methods and Conditions (Commercial Only) cont.**

Test	Reference	Test Condition	Limits
Thermal Shock	MIL-STD-202 Method 107	Number of cycles required 5, (-55°C to 125°C) Dwell time 15 minutes.	Cap: ±0.3% or ±0.25 pF shift DF: Initial Limit IR: Initial Limit
High Temperature Life	MIL-STD-202 Method 108	1,000 hours at 125°C with 1.0 X rated voltage applied	Measurement at 24 hours ±4 hours after test conclusion. Within Post Environmental Limits Cap: ±0.3% or ±0.25 pF shift IR: 10% of Initial Limit DF Limits Maximum: 0.5%
Vibration	MIL-STD-202 Method 204	5 g's for 20 minutes, 12 cycles each of 3 orientations. Test from 10 – 2,000 Hz	Cap: ±0.3% or ±0.25 pF shift DF: Initial Limit IR: Initial Limit
Mechanical Shock	MIL-STD-202 Method 213	1,500 g's 0.5 ms Half-sine, Velocity Change 15.4 feet/second (Condition F)	Cap: ±0.3% or ±0.25 pF shift DF: Initial Limit IR: Initial Limit
Resistance to Soldering Heat	MIL-STD-202 Method 210	Condition K, time above 217°C, 60s – 150s	Cap: ±0.3% or ±0.25 pF shift DF: Initial Limit IR: Initial Limit

## Environmental Compliance



Lead (Pb)-free, RoHS, and REACH compliant without exemptions.

**Table 3 – KONNEKT Land Pattern Design Recommendations per IPC-7351 (mm)**

EIA Size Code	Metric Size Code	Median (Nominal) Land Protrusion														
		STANDARD ORIENTATION					LOW LOSS					LOW LOSS				
		2,3,4-Chip Stack Pad Sizes					3-Chip Stack Pad Size					4-Chip Stack Pad Size				
C	Y	X	V1	V2	C	Y	X	V1	V2	C	Y	X	V1	V2		
1206	3216	1.50	1.15	1.80	4.70	2.30										
1210	3225	1.50	1.15	2.70	4.70	3.20										
1812	4532	2.05	1.40	3.50	6.00	4.00	2.05	1.40	8.40	6.00	8.90					
2220	5750	2.65	1.50	5.40	7.30	5.90	2.65	1.50	8.40	7.30	8.90	2.65	1.50	11.20	7.30	11.70

## Storage & Handling

Ceramic chip capacitors should be stored in normal working environments. While the chips themselves are quite robust in other environments, solderability will be degraded by exposure to high temperatures, high humidity, corrosive atmospheres, and long term storage. In addition, packaging materials will be degraded by high temperature – reels may soften or warp and tape peel force may increase. KEMET recommends that maximum storage temperature not exceed 40°C and maximum storage humidity not exceed 70% relative humidity. In addition, temperature fluctuations should be minimized to avoid condensation on the parts and atmospheres should be free of chlorine and sulfur bearing compounds. For optimized solderability chip stock should be used promptly, preferably within 1.5 years upon receipt.



## Soldering Process

### Recommended Reflow Soldering Profile

KEMET's KONNEKT family of high density surface mount multilayer ceramic capacitors (SMD MLCCs) are compatible with convection and IR reflow techniques. Preheating of these components is recommended to avoid extreme thermal stress. KEMET's recommended profile conditions for convection and IR reflow reflect the profile conditions of the IPC/J-STD-020 standard for moisture sensitivity testing. These devices can safely withstand a maximum of three reflow passes at these conditions.

Profile Feature	Termination Finish
	100% matte Sn
<b>Preheat/Soak</b>	
Temperature Minimum ( $T_{Smin}$ )	150°C
Temperature Maximum ( $T_{Smax}$ )	200°C
Time ( $t_s$ ) from $T_{Smin}$ to $T_{Smax}$	60 – 120 seconds
Ramp-Up Rate ( $T_L$ to $T_p$ )	3°C/second maximum
Liquidous Temperature ( $T_L$ )	217°C
Time Above Liquidous ( $t_L$ )	60 – 150 seconds
Peak Temperature ( $T_p$ )	260°C
Time Within 5°C of Maximum Peak Temperature ( $t_p$ )	30 seconds maximum
Ramp-Down Rate ( $T_p$ to $T_L$ )	6°C/second maximum
Time 25°C to Peak Temperature	8 minutes maximum

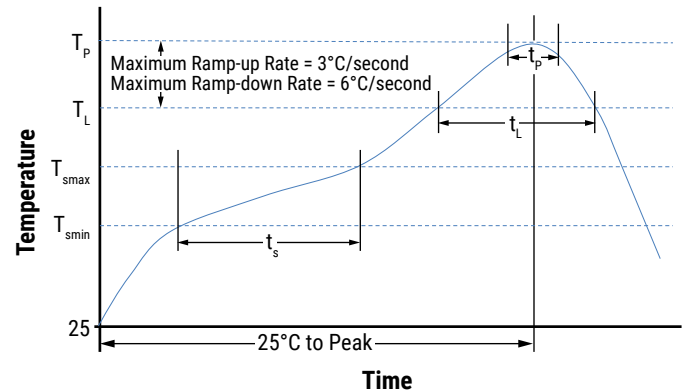

Note: All temperatures refer to the center of the package, measured on the capacitor body surface that is facing up during assembly reflow.

### Hand Soldering and Removal of KONNEKT Capacitors

The preferred method of attachment for KEMET's KONNEKT Capacitors is IR or convection reflow where temperature, time and air flow are well controlled.

However, it is understood that the manual attachment of KONNEKT capacitors is necessary for prototype and lab testing. In these instances, care must be taken not to introduce excessive temperature gradients in the KONNEKT part type that may lead to cracking in the ceramic or separation of the TLPS material.

Please see [KEMET's KONNEKT Soldering Guidelines here](#).

## Construction – Standard Termination

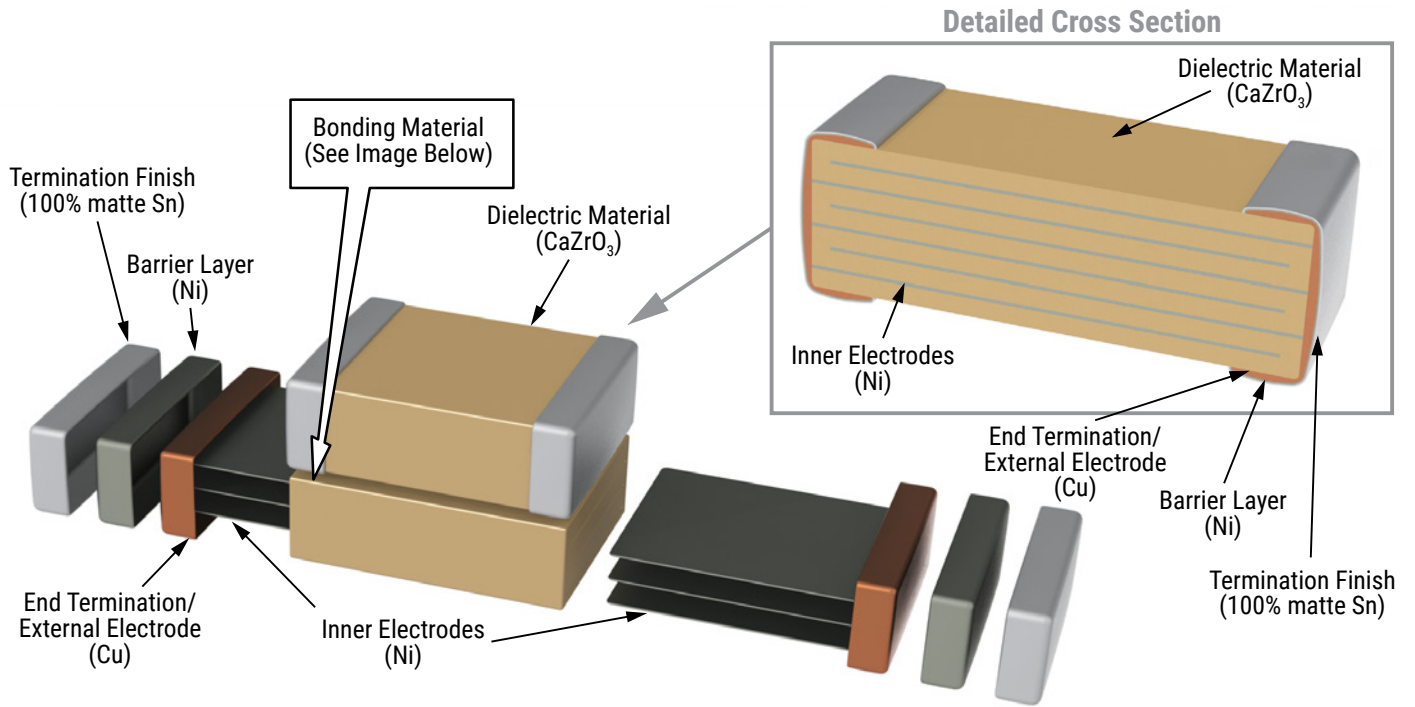

### Bonding Material

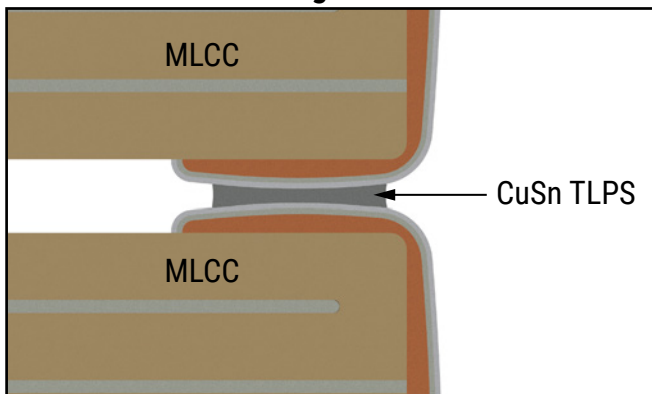

## Tape & Reel Packaging Information

KEMET offers X7R with KONNEKT technology capacitors packaged in 16 mm tape on 7" and 13" reels in accordance with EIA Standard 481. This packaging system is compatible with all tape-fed automatic pick and place systems.

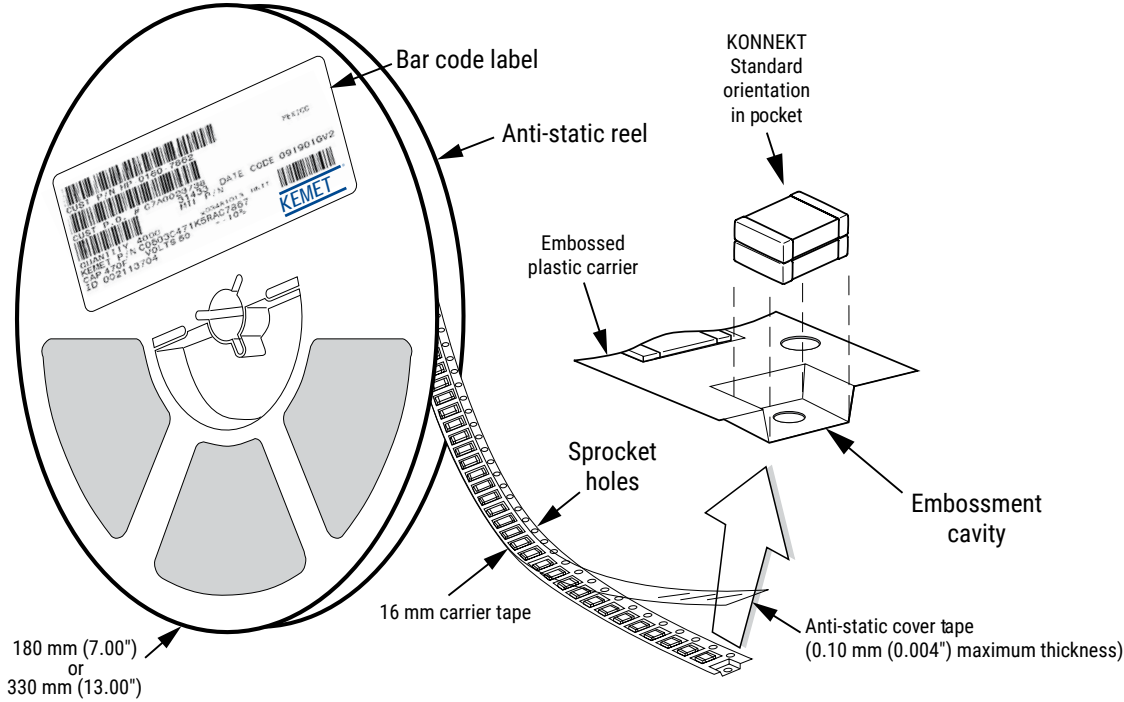

**Table 4 – Carrier Tape Configuration, Embossed Plastic (mm)**

EIA Case Size	Number of Chips	Part Orientation	Tape Size (W) <sup>1</sup>	Embossed Plastic	
				7" Reel	13" Reel
				Pitch (P <sub>1</sub> ) <sup>2</sup>	
1206	2	Standard	16	8	8
1210	2	Standard	16	12	12
				8	8
1812	2	Standard	16	12	12
	3	Standard		16	16
	3	Low Loss		8	8
2220	2	Standard	16	8	8
	3	Standard		12	12
	3	Low Loss		16	16
	4	Low Loss		20	20

1. Refer to Figures 1 and 2 for W and P<sub>1</sub> carrier tape reference locations.

2. Refer to Tables 4 and 5 for tolerance specifications.

**Figure 1 – Embossed (Plastic) Carrier Tape Dimensions**

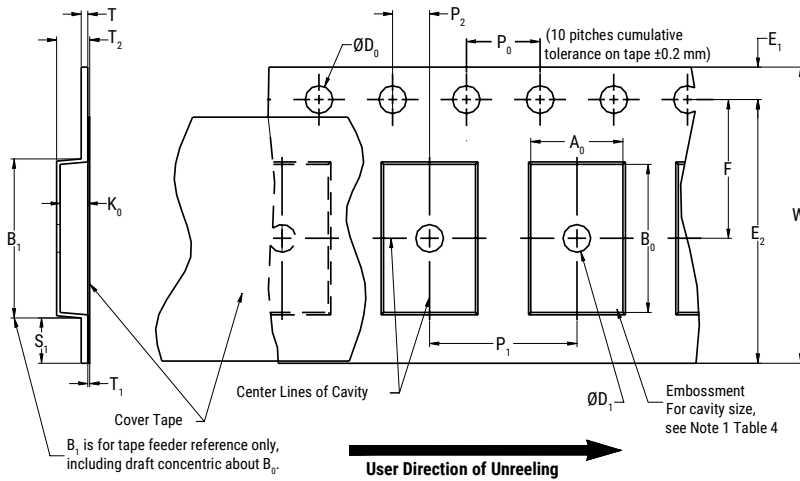

**Table 5 – Embossed (Plastic) Carrier Tape Dimensions**

Metric will govern

Constant Dimensions – Millimeters (Inches)									
Tape Size	D <sub>0</sub>	D <sub>1</sub> Minimum Note 1	E <sub>1</sub>	P <sub>0</sub>	P <sub>2</sub>	R Reference Note 2	S <sub>1</sub> Minimum Note 3	T Maximum	T <sub>1</sub> Maximum
16 mm	1.5 +0.10/-0.0 (0.059 +0.004/-0.0)	1.5 (0.059)	1.75±0.10 (0.069±0.004)	4.0±0.10 (0.157±0.004)	2.0±0.05 (0.079±0.002)	30 (1.181)	0.600 (0.024)	0.600 (0.024)	0.100 (0.004)

Variable Dimensions – Millimeters (Inches)										
Case Size	Number of Chips	Tape Size	Pitch	B <sub>1</sub> Maximum Note 4	E <sub>2</sub> Minimum	F	P <sub>1</sub>	T <sub>2</sub> Maximum	W Maximum	A <sub>0</sub> , B <sub>0</sub> & K <sub>0</sub>
1206	2	16 mm	Double (8mm)	4.35 (0.171)	14.25 (0.561)	7.5±0.05 (0.138±0.002)	8.0±0.10 (0.315±0.004)	6.5 (0.256)	16.3 (0.642)	Note 5
1210	2	16 mm	Triple (12mm)	4.35 (0.171)	14.25 (0.561)	7.5±0.05 (0.138±0.002)	12.0±0.10 (0.472±0.004)	6.5 (0.256)	16.3 (0.642)	Note 5
			Double (8mm)				8.0±0.10 (0.315±0.004)			
1812	2	16 mm	Triple (12mm)	7.9 (0.311)	14.25 (0.561)	7.5±0.05 (0.138±0.002)	12.0±0.10 (0.472±0.004)	6.5 (0.256)	16.3 (0.642)	Note 5
			Double (8mm)	7.5 (0.295)			8.0±0.10 (0.315±0.004)			
2220	2	16 mm	Triple (12mm)	8.5 (0.335)	14.25 (0.561)	7.5±0.05 (0.138±0.002)	12.0±0.10 (0.472±0.004)	6.5 (0.256)	16.3 (0.642)	Note 5
			Double (8mm)	9.2 (0.363)			8.0±0.10 (0.315±0.004)			

- The embossment hole location shall be measured from the sprocket hole controlling the location of the embossment. Dimensions of embossment location and hole location shall be applied independent of each other.
- The tape with or without components shall pass around R without damage (see Figure 6).
- If S<sub>1</sub> < 1.0 mm, there may not be enough area for cover tape to be properly applied. See EIA Document 481, Paragraph 4.3 (b).
- B<sub>1</sub> dimension is a reference dimension for tape feeder clearance only.
- The cavity defined by A<sub>0</sub>, B<sub>0</sub> and K<sub>0</sub> shall surround the component with sufficient clearance that:
  - the component does not protrude above the top surface of the carrier tape.
  - the component can be removed from the cavity in a vertical direction without mechanical restriction, after the top cover tape has been removed.
  - rotation of the component is limited to 20° maximum for 8 and 12 mm tapes and 10° maximum for 16 mm tapes (see Figure 3).
  - lateral movement of the component is restricted to 0.5 mm maximum for 8 mm and 12 mm wide tape and to 1.0 mm maximum for 16 mm tape (see Figure 4).
  - For KPS product, A<sub>0</sub> and B<sub>0</sub> are measured on a plane 0.3 mm above the bottom of the pocket.
  - see Addendum in EIA Document 481 for standards relating to more precise taping requirements.

## Packaging Information Performance Notes

- Cover Tape Break Force:** 1.0 kg minimum.
- Cover Tape Peel Strength:** The total peel strength of the cover tape from the carrier tape shall be:

Tape Width	Peel Strength
16 mm	0.1 to 1.3 newton (10 to 130 gf)

## Table 6 – Reel Dimensions

Metric will govern

Constant Dimensions – Millimeters (Inches)				
Tape Size	A	B Minimum	C	D Minimum
16 mm	178±0.20 (7.008±0.008) or 330±0.20 (13.000±0.008)	1.5 (0.059)	13.0 +0.5/-0.2 (0.521 +0.02/-0.008)	20.2 (0.795)
Variable Dimensions – Millimeters (Inches)				
Tape Size	N Minimum See Note 2, Tables 2-3	W <sub>1</sub>	W <sub>2</sub> Maximum	W <sub>3</sub>
16 mm	50 (1.969)	16.4 +2.0/-0.0 (0.646 +0.078/-0.0)	22.4 (0.882)	Shall accommodate tape width without interference

## KEMET Electronics Corporation Sales Offices

For a complete list of our global sales offices, please visit [www.kemet.com/sales](http://www.kemet.com/sales).

---

### Disclaimer

YAGEO Corporation and its affiliates do not recommend the use of commercial or automotive grade products for high reliability applications or manned space flight.

All product specifications, statements, information and data (collectively, the "Information") in this datasheet are subject to change. The customer is responsible for checking and verifying the extent to which the Information contained in this publication is applicable to an order at the time the order is placed. All Information given herein is believed to be accurate and reliable, but it is presented without guarantee, warranty, or responsibility of any kind, expressed or implied.

Statements of suitability for certain applications are based on KEMET Electronics Corporation's ("KEMET") knowledge of typical operating conditions for such applications, but are not intended to constitute – and KEMET specifically disclaims – any warranty concerning suitability for a specific customer application or use. The Information is intended for use only by customers who have the requisite experience and capability to determine the correct products for their application. Any technical advice inferred from this Information or otherwise provided by KEMET with reference to the use of KEMET's products is given gratis, and KEMET assumes no obligation or liability for the advice given or results obtained.

Although KEMET designs and manufactures its products to the most stringent quality and safety standards, given the current state of the art, isolated component failures may still occur. Accordingly, customer applications which require a high degree of reliability or safety should employ suitable designs or other safeguards (such as installation of protective circuitry or redundancies) in order to ensure that the failure of an electrical component does not result in a risk of personal injury or property damage.

Although all product-related warnings, cautions and notes must be observed, the customer should not assume that all safety measures are indicated or that other measures may not be required.

*KEMET is a registered trademark of KEMET Electronics Corporation.*