

Overview

The A50 Series is constructed of metallized polyester film (wound technology) with axial leads of tinned wire. Axial leads are electrically welded to the contact metal layer on the ends of the capacitor winding. The capacitor is encapsulated in polyester tape wrapping with the thermosetting resin ends filled.

Automotive grade devices meet the demanding Automotive Electronics Council's AEC-Q200 qualification requirements.

Applications

Typical applications include blocking, coupling, decoupling, bypassing, and interference suppression in low voltage applications such as automotive. Not suitable for across-the-line application (see Suppressor Capacitors).

Benefits

- Voltage range: 50 – 1,000 VDC
- Capacitance range: 0.001 – 10 μ F
- Diameter: 5 – 22 mm
- Length 11 – 33 mm
- Capacitance tolerance: \pm 5%, \pm 10%, \pm 20%
- Climatic category: 55/105/56
- Operating temperature range of -55°C to $+105^{\circ}\text{C}$
- RoHS Compliant and lead-free terminations
- Tape & Reel packaging in accordance with IEC 60286-1
- Self-Healing
- Automotive grade (AEC-Q200)

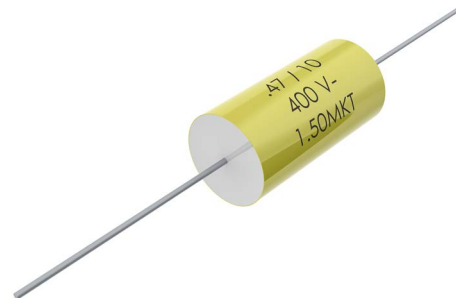

Part Number System

A50	C	F	3470	AA	00	J
Series	Rated Voltage (VDC)	Length (mm)	Capacitance Code (μ F)	Packaging	Internal Use	Capacitance Tolerance
Metallized Polyester	C = 50 D = 63 E = 100 I = 250 M = 400 P = 630 Q = 1,000	F = 11.0 H = 14.0 K = 20.5 Q = 28.0 T = 33.0	The last three digits represent significant figures. First digit specifies the number of zeros to be added.	See Ordering Options Table	00, 60 (Standard)	J = \pm 5% K = \pm 10% M = \pm 20%

Ordering Options Table

Type of Leads and Packaging	LL/I Lead Length (mm)	Lead and Packaging Code
Standard Lead and Packaging Options		
Bulk (Bag) – Short Leads	40.0 ±5	AA
Tape & Reel (Standard Reel Ø 355 mm)	≥ 20	26

Dimensions – Millimeters



D		L		d	
Nominal	Tolerance	Nominal	Tolerance	Nominal	Tolerance
5.0	Maximum	11.0	Maximum	0.6	Maximum
5.0	Maximum	14.0	Maximum	0.6	Maximum
5.5	Maximum	14.0	Maximum	0.6	Maximum
6.0	Maximum	14.0	Maximum	0.6	Maximum
6.0	Maximum	20.5	Maximum	0.6	Maximum
6.5	Maximum	11.0	Maximum	0.6	Maximum
6.5	Maximum	20.5	Maximum	0.6	Maximum
6.5	Maximum	14.0	Maximum	0.6	Maximum
7.0	Maximum	14.0	Maximum	0.8	Maximum
7.0	Maximum	20.5	Maximum	0.8	Maximum
7.0	Maximum	28.0	Maximum	0.8	Maximum
7.5	Maximum	20.5	Maximum	0.8	Maximum
7.5	Maximum	14.0	Maximum	0.8	Maximum
8.0	Maximum	14.0	Maximum	0.8	Maximum
8.0	Maximum	20.5	Maximum	0.8	Maximum
8.0	Maximum	28.0	Maximum	0.8	Maximum
8.5	Maximum	20.5	Maximum	0.8	Maximum
8.5	Maximum	28.0	Maximum	0.8	Maximum
9.0	Maximum	20.5	Maximum	0.8	Maximum
9.0	Maximum	28.0	Maximum	0.8	Maximum
9.5	Maximum	20.5	Maximum	0.8	Maximum
9.5	Maximum	28.0	Maximum	0.8	Maximum

Note: See Ordering Options Table for lead length (LL/I) options.

D		L		d	
Nominal	Tolerance	Nominal	Tolerance	Nominal	Tolerance
10.0	Maximum	20.5	Maximum	0.8	Maximum
10.0	Maximum	33.0	Maximum	0.8	Maximum
10.0	Maximum	28.0	Maximum	0.8	Maximum
10.5	Maximum	33.0	Maximum	0.8	Maximum
10.5	Maximum	28.0	Maximum	0.8	Maximum
11.0	Maximum	28.0	Maximum	0.8	Maximum
11.0	Maximum	33.0	Maximum	0.8	Maximum
11.5	Maximum	33.0	Maximum	0.8	Maximum
12.0	Maximum	20.5	Maximum	0.8	Maximum
12.0	Maximum	33.0	Maximum	0.8	Maximum
12.5	Maximum	33.0	Maximum	0.8	Maximum
12.5	Maximum	28.0	Maximum	0.8	Maximum
13.0	Maximum	33.0	Maximum	0.8	Maximum
13.5	Maximum	33.0	Maximum	0.8	Maximum
14.5	Maximum	33.0	Maximum	0.8	Maximum
15.0	Maximum	33.0	Maximum	0.8	Maximum
15.5	Maximum	33.0	Maximum	0.8	Maximum
16.0	Maximum	33.0	Maximum	0.8	Maximum
17.5	Maximum	33.0	Maximum	1	Maximum
18.5	Maximum	33.0	Maximum	1	Maximum
19.0	Maximum	33.0	Maximum	1	Maximum
22.0	Maximum	33.0	Maximum	1	Maximum

Note: See Ordering Options Table for lead length (LL/I) options.

Performance Characteristics

Dielectric	Polyester film (polyethylene terephthalate)						
Plates	Metal layer deposited by evaporation under vacuum						
Winding	Non-inductive type						
Leads	Tinned wire						
Protection	Plastic case, thermosetting resin filled. Box material is solvent resistant and flame retardant according to UL94.						
Related Documents	IEC 60384-2						
Rated Voltage V_R (VDC)	50	63	100	250	400	630	1,000
Rated Voltage V_R (VAC)	30	40	63	160	200	220	250
Capacitance Range (μ F)	0.47 – 10.0	0.33 – 10.0	0.1 – 10.0	0.047 – 10.0	0.01 – 3.3	0.001 – 1	0.001 – 0.47
Capacitance Values	E6 series (IEC 60063) measured at 1 kHz and +20 \pm 1 $^\circ$ C						
Capacitance Tolerance	\pm 5%, \pm 10%, \pm 20%						
Operating Temperature Range	-55 $^\circ$ C to 105 $^\circ$ C						
Rated Temperature T_R	+85 $^\circ$ C						
Voltage Derating	Above +85 $^\circ$ C DC and AC voltage derating is 1.25%/ $^\circ$ C						
Climatic Category	55/105/56 IEC 60068-1						
Storage Conditions	Storage time: \leq 24 months from the date marked on the label package						
	Average relative humidity per year \leq 70%						
	RH \leq 85% for 30 days randomly distributed throughout the year						
	Dew is absent						
	Temperature: -40 to 80 $^\circ$ C (see "Maximum Humidity in Storage Conditions" graph below)						
Test Voltage	1.6 x V_R VDC for 2 seconds (between terminations) at +25 $^\circ$ C \pm 5 $^\circ$ C						
Capacitance Drift	Maximum 3% after a 2 year storage period at a temperature of +10 $^\circ$ C to +40 $^\circ$ C and a relative humidity of 40% to 60%						
Reliability (Reference IEC-61709)	Operational life >200,000 hours						
	Failure rate \leq 5 FIT, T = +40 $^\circ$ C, V = 0.5 x V_R						
	Failure criteria: open or short circuit, cap. change > 10%, DF 2 times the catalog limits, IR < 0.005 x initial limit						
Maximum Pulse Steepness	dV/dt according to Table 1. For peak to peak voltages lower than rated voltage ($V_{pp} < V_R$), the specified dv/dt can be multiplied by the factor V_R/V_{pp}						
Temperature Coefficient	+400 (\pm 200) ppm/ $^\circ$ C at 1 kHz						

Performance Characteristics cont.

Self Inductance (Lead Length ~ 2 mm)	Approximately 7 nH. Maximum 1nH per 1 mm lead and capacitor length.			
Dissipation Factor $\tan\delta$	Maximum Values at 25°C ±5°C			
	Frequency	C ≤ 0.1 μF	0.1 μF < C ≤ 1 μF	C > 1 μF
	1 kHz	0.80%	0.80%	1.00%
	10 kHz	1.50%	1.50%	–
100 kHz	2.50%	–	–	–
Insulation Resistance	Measured at +25°C ±5°C, according to IEC 60384-2			
	Minimum Values Between Terminals			
	Voltage Charge/Time	C ≤ 0.33 μF	C > 0.33 μF	
	50 VDC for V _R ≤ 100 VDC 1 minute	≥ 3,750 MΩ (≥ 50,000 MΩ)*	≥ 1,000 MΩ · μF (≥ 5,000 MΩ · μF)*	
100 VDC for V _R > 100 VDC 1 minute	≥ 30,000 MΩ (≥ 50,000 MΩ)*	≥ 10,000 MΩ · μF (≥ 17,000 MΩ · μF)*		

* typical value

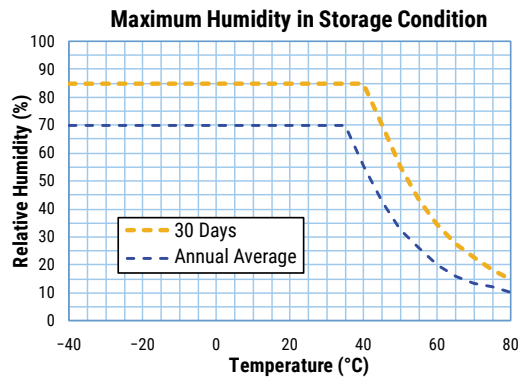

T_h is the maximum ambient temperature surrounding the capacitor or hottest contact point (e.g. tracks), whichever is higher, in the worst operation conditions in °C.

Qualification

Automotive Grade products meet or exceed the requirements outlined by the Automotive Electronics Council. Details regarding test methods and conditions are referenced in document AEC-Q200, Stress Test Qualification for Passive Components. For additional information regarding the Automotive Electronics Council and AEC-Q200, please visit their website at www.aecouncil.com.

Maximum Voltage (V_{rms}) vs. Frequency (Sinusoidal Waveform/ $T_h \leq 40^\circ C$)

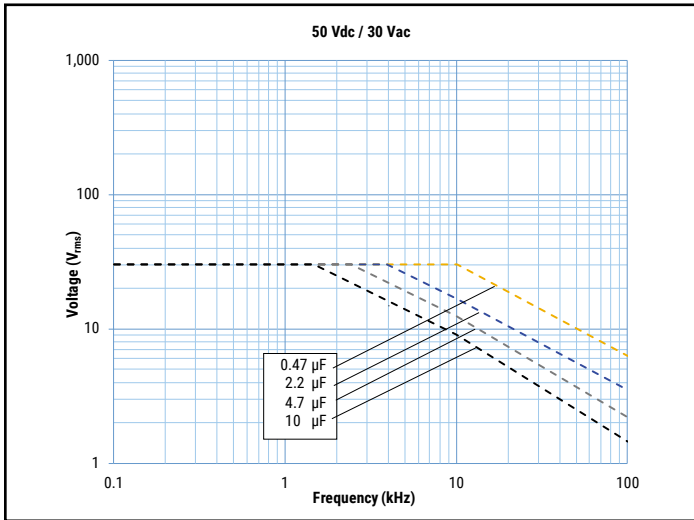

Maximum Voltage (V_{rms}) vs. Frequency (Sinusoidal Waveform/ $T_h \leq 40^\circ C$) cont.

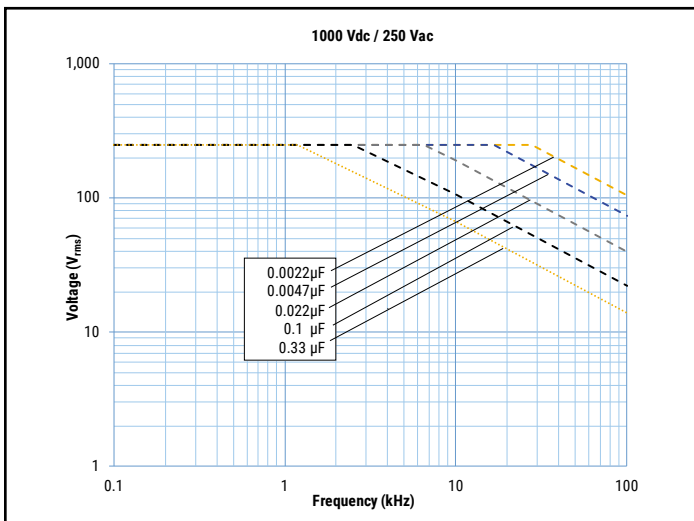
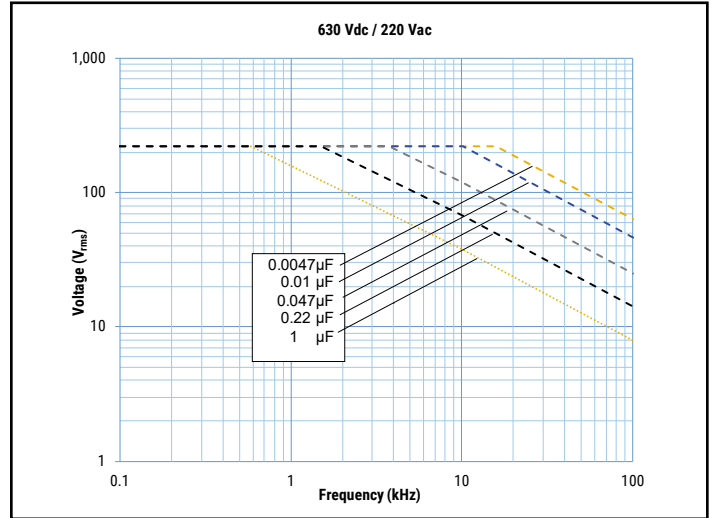
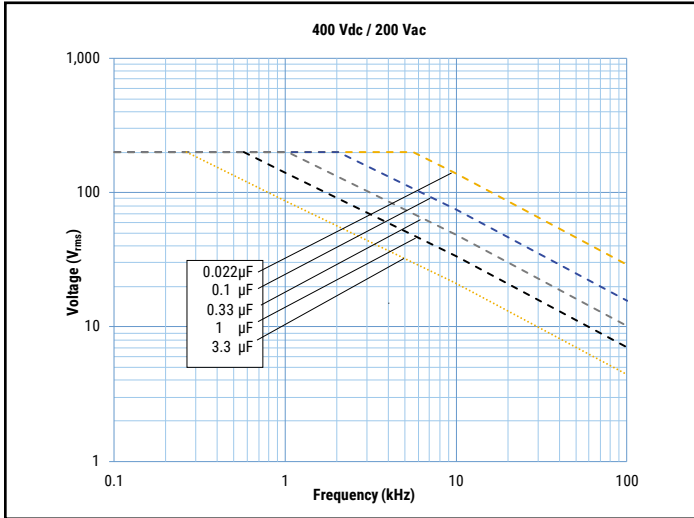

Maximum Current (I_{rms}) vs. Frequency (Sinusoidal Waveform/ $T_h \leq 40^\circ\text{C}$)

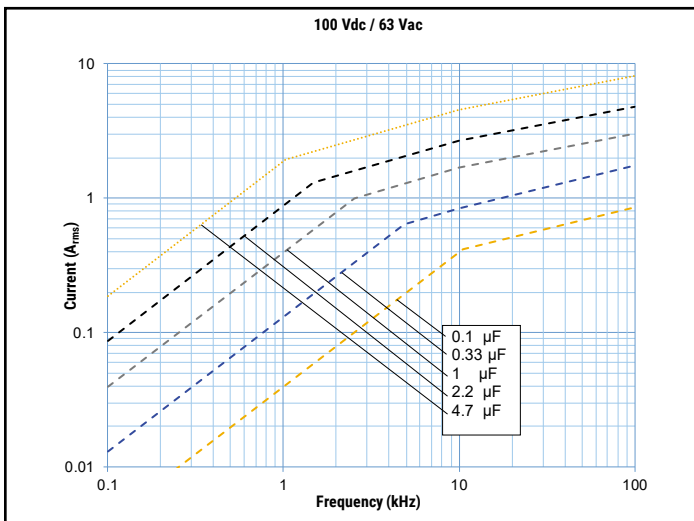

Maximum Current (I_{rms}) vs. Frequency (Sinusoidal Waveform/ $T_h \leq 40^\circ\text{C}$) cont.

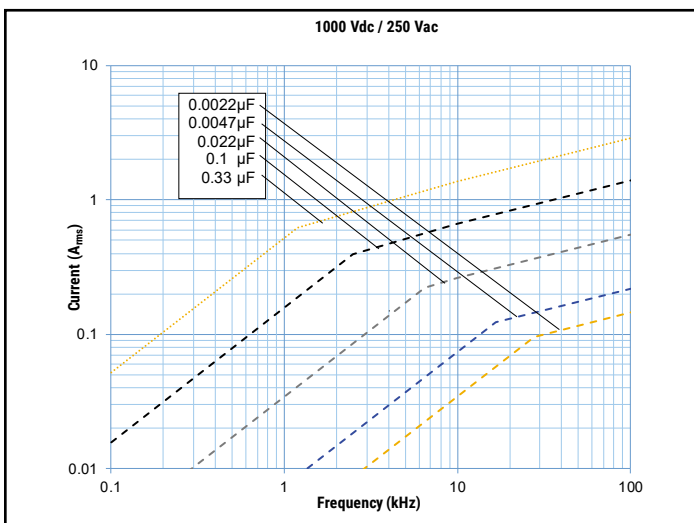
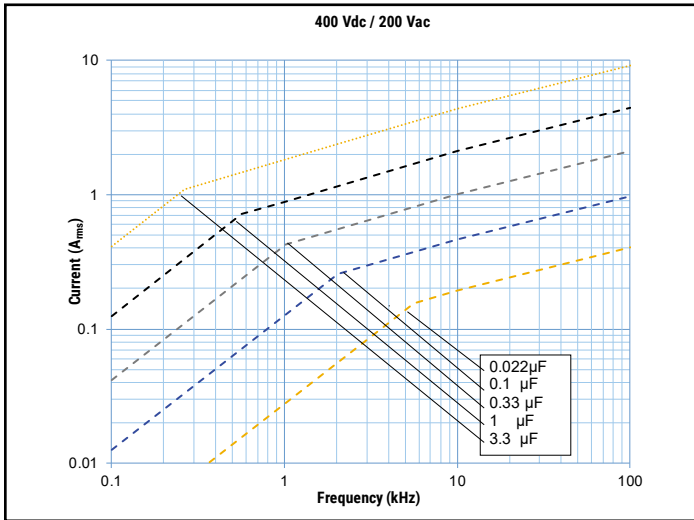

Environmental Test Data

Damp Heat, Steady State Test	Test Conditions:		Performances
	Temperature:	+40°C ±2°C	Δ C/C ≤ 5%, Δ tanδ ≤ 0.005 at 1 kHz IR after test ≥ 50% of initial limit
	Relative humidity (RH):	93% ±2%	
	Test duration:	56 days	
Endurance Test	Test Conditions		Performances
	Temperature:	+85°C ±2°C	Δ C/C ≤ 5%, Δ tanδ ≤ 0.003 at 10 kHz for C ≤ 1 μF Δ tanδ ≤ 0.002 at 1 kHz for C > 1 μF IR after test ≥ 50% of initial limit
	Voltage applied:	1.25 x V _R	
	Test duration:	2,000 hours	
Resistance to Soldering Heat Test	Test Conditions		Performances
	Solder bath temperature:	260°C ±5°C	Δ C/C ≤ 2%, Δ tanδ ≤ 0.003 at 10 kHz for C ≤ 1 μF Δ tanδ ≤ 0.002 at 1 kHz for C > 1 μF IR after test ≥ initial limit
	Dipping time (with heat screen):	10 seconds ±1 second	

Environmental Compliance

All KEMET MKT capacitors are RoHS Compliant.



Table 1 – Ratings & Part Number Reference

VDC	VAC	Capacitance Value (µF)	Dimensions in mm		dV/dt (V/µs)	Max K ₀ (V ² /µs)	KEMET Part Number	Legacy Part Number
			D	L				
50	30	0.47	5.0	11.0	4.0	400	50CF3470(1)00(2)	A50CF3470(1)00(2)
50	30	0.68	5.0	11.0	4.0	400	50CF3680(1)00(2)	A50CF3680(1)00(2)
50	30	1.0	6.5	11.0	4.0	400	50CF4100(1)00(2)	A50CF4100(1)00(2)
50	30	1.5	7.0	14.0	4.0	400	50CH4150(1)00(2)	A50CH4150(1)00(2)
50	30	2.2	8.0	14.0	4.0	400	50CH4220(1)00(2)	A50CH4220(1)00(2)
50	30	3.3	7.5	20.5	2.0	200	50CK4330(1)00(2)	A50CK4330(1)00(2)
50	30	4.7	8.5	20.5	2.0	200	50CK4470(1)00(2)	A50CK4470(1)00(2)
50	30	6.8	10.0	20.5	2.0	200	50CK4680(1)00(2)	A50CK4680(1)00(2)
50	30	10.0	12.0	20.5	2.0	200	50CK5100(1)00(2)	A50CK5100(1)00(2)
63	40	0.33	5.0	11.0	4.0	500	50DF3330(1)60(2)	A50DF3330(1)60(2)
63	40	0.47	6.0	14.0	4.0	500	50DH3470(1)60(2)	A50DH3470(1)60(2)
63	40	0.68	6.0	14.0	4.0	500	50DH3680(1)60(2)	A50DH3680(1)60(2)
63	40	1.0	7.0	14.0	4.0	500	50DH4100(1)60(2)	A50DH4100(1)60(2)
63	40	1.5	6.5	20.5	2.0	250	50DK4150(1)60(2)	A50DK4150(1)60(2)
63	40	2.2	8.0	20.5	2.0	250	50DK4220(1)60(2)	A50DK4220(1)60(2)
63	40	3.3	9.5	20.5	2.0	250	50DK4330(1)60(2)	A50DK4330(1)60(2)
63	40	4.7	9.5	28.0	1.5	190	50DQ4470(1)60(2)	A50DQ4470(1)60(2)
63	40	6.8	11.0	28.0	1.5	190	50DQ4680(1)60(2)	A50DQ4680(1)60(2)
63	40	10.0	11.5	33.0	1.0	130	50DT5100(1)60(2)	A50DT5100(1)60(2)
100	63	0.10	5.0	11.0	5.0	1000	50EF3100(1)60(2)	A50EF3100(1)60(2)
100	63	0.15	5.0	11.0	5.0	1000	50EF3150(1)60(2)	A50EF3150(1)60(2)
100	63	0.22	5.0	11.0	5.0	1000	50EF3220(1)60(2)	A50EF3220(1)60(2)
100	63	0.33	6.0	14.0	5.0	1000	50EH3330(1)60(2)	A50EH3330(1)60(2)
100	63	0.47	6.0	14.0	5.0	1000	50EH3470(1)60(2)	A50EH3470(1)60(2)
100	63	0.68	7.0	14.0	5.0	1000	50EH3680(1)60(2)	A50EH3680(1)60(2)
100	63	1.0	7.0	20.5	3.0	600	50EK4100(1)60(2)	A50EK4100(1)60(2)
100	63	1.5	8.0	20.5	3.0	600	50EK4150(1)60(2)	A50EK4150(1)60(2)
100	63	2.2	9.5	20.5	3.0	600	50EK4220(1)60(2)	A50EK4220(1)60(2)
100	63	3.3	9.5	28.0	2.0	400	50EQ4330(1)60(2)	A50EQ4330(1)60(2)
100	63	4.7	10.0	33.0	1.0	300	50ET4470(1)60(2)	A50ET4470(1)60(2)
100	63	6.8	12.0	33.0	1.0	300	50ET4680(1)60(2)	A50ET4680(1)60(2)
100	63	10.0	14.5	33.0	1.0	300	50ET5100(1)60(2)	A50ET5100(1)60(2)
250	160	0.047	5.0	11.0	10.0	5000	50IF2470(1)60(2)	A50IF2470(1)60(2)
250	160	0.068	5.0	11.0	10.0	5000	50IF2680(1)60(2)	A50IF2680(1)60(2)
250	160	0.10	5.5	14.0	10.0	5000	50IH3100(1)60(2)	A50IH3100(1)60(2)
250	160	0.15	5.5	14.0	10.0	5000	50IH3150(1)60(2)	A50IH3150(1)60(2)
250	160	0.22	6.5	14.0	10.0	5000	50IH3220(1)60(2)	A50IH3220(1)60(2)
250	160	0.33	6.0	20.5	7.0	3500	50IK3330(1)60(2)	A50IK3330(1)60(2)
250	160	0.47	7.0	20.5	7.0	3500	50IK3470(1)60(2)	A50IK3470(1)60(2)
250	160	0.68	8.5	20.5	7.0	3500	50IK3680(1)60(2)	A50IK3680(1)60(2)
250	160	1.0	8.5	28.0	4.0	2000	50IQ4100(1)60(2)	A50IQ4100(1)60(2)
250	160	1.5	10.0	28.0	4.0	2000	50IQ4150(1)60(2)	A50IQ4150(1)60(2)
250	160	2.2	11.0	33.0	2.5	1300	50IT4220(1)60(2)	A50IT4220(1)60(2)
250	160	3.3	13.0	33.0	2.5	1300	50IT4330(1)60(2)	A50IT4330(1)60(2)
250	160	4.7	15.5	33.0	2.5	1300	50IT4470(1)60(2)	A50IT4470(1)60(2)
250	160	6.8	18.5	33.0	2.5	1300	50IT4680(1)60(2)	A50IT4680(1)60(2)
250	160	10.0	22.0	33.0	2.5	1300	50IT5100(1)60(2)	A50IT5100(1)60(2)
400	200	0.010	5.0	11.0	13.5	11000	50MF2100(1)60(2)	A50MF2100(1)60(2)
400	200	0.015	5.0	11.0	13.5	11000	50MF2150(1)60(2)	A50MF2150(1)60(2)
400	200	0.022	5.0	11.0	13.5	11000	50MF2220(1)60(2)	A50MF2220(1)60(2)
400	200	0.033	5.0	11.0	13.5	11000	50MF2330(1)60(2)	A50MF2330(1)60(2)
400	200	0.047	6.0	14.0	13.5	11000	50MH2470(1)60(2)	A50MH2470(1)60(2)
400	200	0.068	6.0	14.0	13.5	11000	50MH2680(1)60(2)	A50MH2680(1)60(2)
400	200	0.10	6.5	14.0	13.5	11000	50MH3100(1)60(2)	A50MH3100(1)60(2)
400	200	0.15	6.0	20.5	10.0	8000	50MK3150(1)60(2)	A50MK3150(1)60(2)
400	200	0.22	7.5	20.5	10.0	8000	50MK3220(1)60(2)	A50MK3220(1)60(2)
400	200	0.33	8.5	20.5	10.0	8000	50MK3330(1)60(2)	A50MK3330(1)60(2)
400	200	0.47	8.5	28.0	6.5	5200	50MQ3470(1)60(2)	A50MQ3470(1)60(2)
400	200	0.68	10.0	28.0	6.5	5200	50MQ3680(1)60(2)	A50MQ3680(1)60(2)
VDC	VAC	Capacitance Value (µF)	D (mm)	L (mm)	dV/dt (V/µs)	Max K ₀ (V ² /µs)	KEMET Part Number	Legacy Part Number

(1) Insert lead and packaging code. See Ordering Options Table for available options.
(2) J = 5%, K = 10%, M = 20%.

Table 1 – Ratings & Part Number Reference cont.

VDC	VAC	Capacitance Value (µF)	Dimensions in mm		dV/dt (V/µs)	Max K ₀ (V ² /µs)	KEMET Part Number	Legacy Part Number
			D	L				
400	200	1.0	10.5	33.0	4.0	3200	50MT4100(1)60(2)	A50MT4100(1)60(2)
400	200	1.5	12.5	33.0	4.0	3200	50MT4150(1)60(2)	A50MT4150(1)60(2)
400	200	2.2	15.0	33.0	4.0	3200	50MT4220(1)60(2)	A50MT4220(1)60(2)
400	200	3.3	18.5	33.0	4.0	3200	50MT4330(1)60(2)	A50MT4330(1)60(2)
630	220	0.0010	5.0	11.0	20.0	250000	50PF1100(1)60(2)	A50PF1100(1)60(2)
630	220	0.0015	5.0	11.0	20.0	250000	50PF1150(1)60(2)	A50PF1150(1)60(2)
630	220	0.0022	5.0	11.0	20.0	250000	50PF1220(1)60(2)	A50PF1220(1)60(2)
630	220	0.0033	5.0	11.0	20.0	250000	50PF1330(1)60(2)	A50PF1330(1)60(2)
630	220	0.0047	5.0	11.0	20.0	250000	50PF1470(1)60(2)	A50PF1470(1)60(2)
630	220	0.0068	5.0	11.0	20.0	250000	50PF1680(1)60(2)	A50PF1680(1)60(2)
630	220	0.010	5.0	14.0	20.0	250000	50PH2100(1)60(2)	A50PH2100(1)60(2)
630	220	0.015	5.0	14.0	20.0	250000	50PH2150(1)60(2)	A50PH2150(1)60(2)
630	220	0.022	6.0	14.0	20.0	250000	50PH2220(1)60(2)	A50PH2220(1)60(2)
630	220	0.033	6.0	20.5	15.0	190000	50PK2330(1)60(2)	A50PK2330(1)60(2)
630	220	0.047	6.0	20.5	15.0	190000	50PK2470(1)60(2)	A50PK2470(1)60(2)
630	220	0.068	7.0	20.5	15.0	190000	50PK2680(1)60(2)	A50PK2680(1)60(2)
630	220	0.10	7.0	28.0	10.0	130000	50PQ3100(1)60(2)	A50PQ3100(1)60(2)
630	220	0.15	8.5	28.0	10.0	130000	50PQ3150(1)60(2)	A50PQ3150(1)60(2)
630	220	0.22	10.0	28.0	10.0	130000	50PQ3220(1)60(2)	A50PQ3220(1)60(2)
630	220	0.33	10.5	33.0	6.0	7500	50PT3330(1)60(2)	A50PT3330(1)60(2)
630	220	0.47	12.0	33.0	6.0	7500	50PT3470(1)60(2)	A50PT3470(1)60(2)
630	220	0.68	14.5	33.0	6.0	7500	50PT3680(1)60(2)	A50PT3680(1)60(2)
630	220	1.0	17.5	33.0	6.0	7500	50PT4100(1)60(2)	A50PT4100(1)60(2)
1000	250	0.0010	6.5	14.0	50.0	100000	50QH1100(1)00(2)	A50QH1100(1)00(2)
1000	250	0.0015	6.5	14.0	50.0	100000	50QH1150(1)00(2)	A50QH1150(1)00(2)
1000	250	0.0022	6.5	14.0	50.0	100000	50QH1220(1)00(2)	A50QH1220(1)00(2)
1000	250	0.0033	6.5	14.0	50.0	100000	50QH1330(1)00(2)	A50QH1330(1)00(2)
1000	250	0.0047	7.5	14.0	50.0	100000	50QH1470(1)00(2)	A50QH1470(1)00(2)
1000	250	0.0068	8.0	14.0	50.0	100000	50QH1680(1)00(2)	A50QH1680(1)00(2)
1000	250	0.010	7.0	20.5	30.0	60000	50QK2100(1)00(2)	A50QK2100(1)00(2)
1000	250	0.015	7.5	20.5	30.0	60000	50QK2150(1)00(2)	A50QK2150(1)00(2)
1000	250	0.022	9.0	20.5	30.0	60000	50QK2220(1)00(2)	A50QK2220(1)00(2)
1000	250	0.033	8.0	28.0	15.0	30000	50QQ2330(1)00(2)	A50QQ2330(1)00(2)
1000	250	0.047	9.0	28.0	15.0	30000	50QQ2470(1)00(2)	A50QQ2470(1)00(2)
1000	250	0.068	10.5	28.0	15.0	30000	50QQ2680(1)00(2)	A50QQ2680(1)00(2)
1000	250	0.10	12.5	28.0	15.0	30000	50QQ3100(1)00(2)	A50QQ3100(1)00(2)
1000	250	0.15	13.5	33.0	10.0	20000	50QT3150(1)00(2)	A50QT3150(1)00(2)
1000	250	0.22	16.0	33.0	10.0	20000	50QT3220(1)00(2)	A50QT3220(1)00(2)
1000	250	0.33	19.0	33.0	10.0	20000	50QT3330(1)00(2)	A50QT3330(1)00(2)
1000	250	0.47	22.0	33.0	10.0	20000	50QT3470(1)00(2)	A50QT3470(1)00(2)
VDC	VAC	Capacitance Value (µF)	D (mm)	L (mm)	dV/dt (V/µs)	Max K ₀ (V ² /µs)	KEMET Part Number	Legacy Part Number

(1) Insert lead and packaging code. See Ordering Options Table for available options.

(2) J = 5%, K = 10%, M = 20%.

Soldering Process

The implementation of the RoHS directive has resulted in the selection of SnAgCu (SAC) alloys or SnCu alloys as primary solder. This has increased the liquidus temperature from that of 183°C for SnPb eutectic alloy to 217 – 221°C for the new alloys. As a result, the heat stress to the components, even in wave soldering, has increased considerably due to higher pre-heat and wave temperatures. Polypropylene capacitors are especially sensitive to heat (the melting point of polypropylene is 160 – 170°C). Wave soldering can be destructive, especially for mechanically small polypropylene capacitors (with lead spacing of 5 to 15 mm), and great care has to be taken during soldering. The recommended solder profiles from KEMET should be used. Please consult KEMET with any questions. In general, the wave soldering curve from IEC Publication 61760-1 Edition 2, serves as a solid guideline for successful soldering. Please see Figure 1.

Reflow soldering is not recommended for through-hole film capacitors. Exposing capacitors to a soldering profile in excess of the above the recommended limits may result to degradation or permanent damage to the capacitors.

Do not place the polypropylene capacitor through an adhesive curing oven to cure resin for surface mount components. Insert through-hole parts after the curing of surface mount parts. Consult KEMET to discuss the actual temperature profile in the oven, if through-hole components must pass through the adhesive curing process. A maximum two soldering cycles is recommended. Please allow time for the capacitor surface temperature to return to a normal temperature before the second soldering cycle.

Manual Soldering Recommendations

Following is the recommendation for manual soldering with a soldering iron.

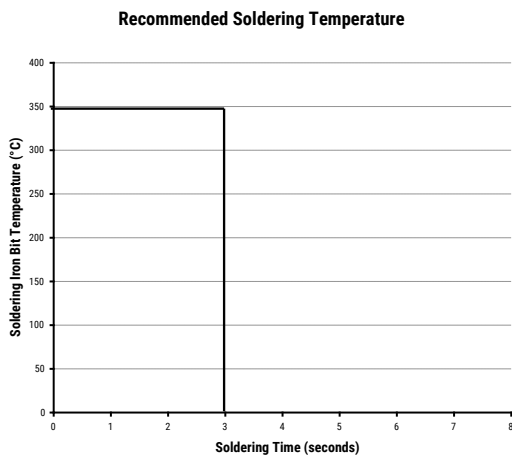

The soldering iron tip temperature should be set at 350°C (+10°C maximum) with the soldering duration not to exceed more than 3 seconds.

Wave Soldering Recommendations

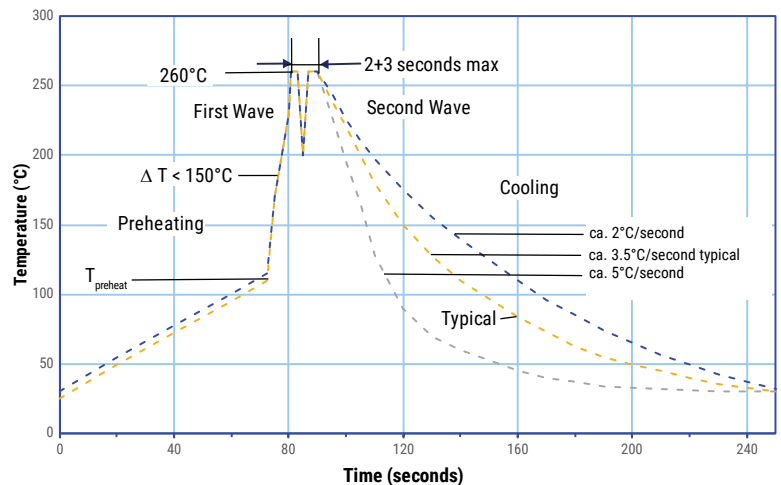

Soldering Process cont.

Wave Soldering Recommendations cont.

1. The table indicates the maximum set-up temperature of the soldering process
Figure 1.

Dielectric Film Material	Maximum Preheat Temperature		Maximum Peak Soldering Temperature	
	Capacitor Pitch ≤ 15 mm	Capacitor Pitch > 15 mm	Capacitor Pitch ≤ 15 mm	Capacitor Pitch > 15 mm
Polyester	130°C	130°C	270°C	270°C
Polypropylene	110°C	130°C	260°C	270°C
Paper	130°C	140°C	270°C	270°C
Polyphenylene Sulphide	150°C	160°C	270°C	270°C

2. The maximum temperature measured inside the capacitor:

Set the temperature so that inside the element the maximum temperature is below the limit:

Dielectric Film Material	Maximum temperature measured inside the element
Polyester	160°C
Polypropylene	110°C
Paper	160°C
Polyphenylene Sulphide	160°C



Temperature monitored inside the capacitor.

Selective Soldering Recommendations

Selective dip soldering is a variation of reflow soldering. In this method, the printed circuit board with through-hole components to be soldered is preheated and transported over the solder bath as in normal flow soldering without touching the solder. When the board is over the bath, it is stopped and pre-designed solder pots are lifted from the bath with molten solder only at the places of the selected components, and pressed against the lower surface of the board to solder the components.

The temperature profile for selective soldering is similar to the double wave flow soldering outlined in this document, **however, instead of two baths, there is only one bath with a time from 3 to 10 seconds.** In selective soldering, the risk of overheating is greater than in double wave flow soldering, and great care must be taken so that the parts are not overheated.

Construction

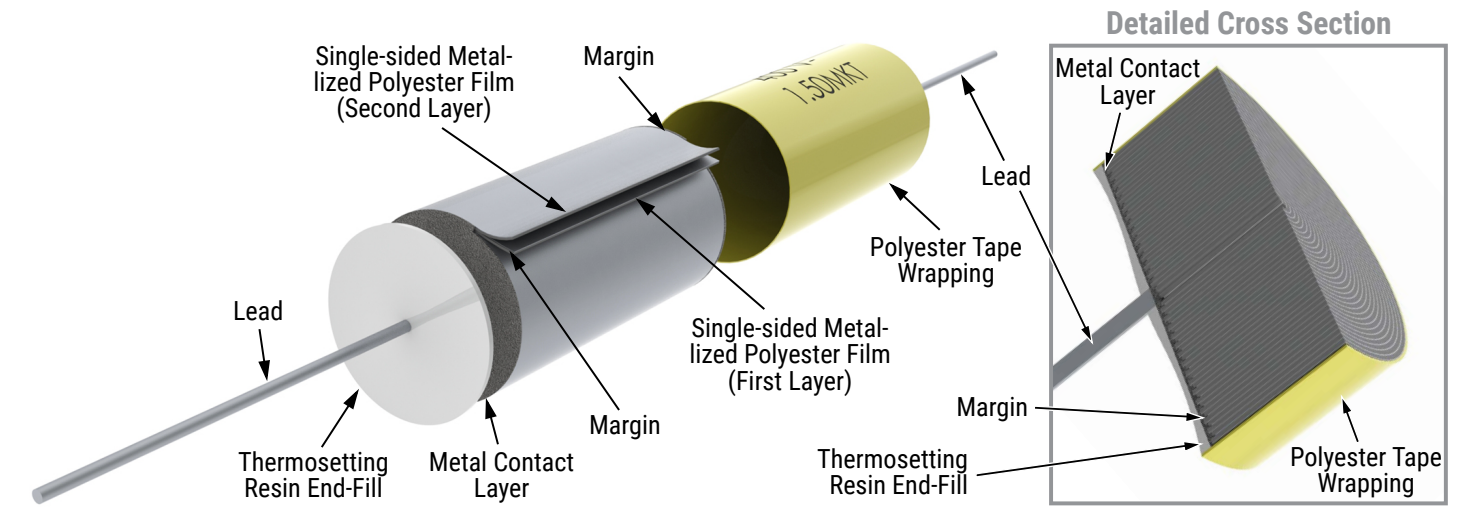

Winding Scheme



Marking

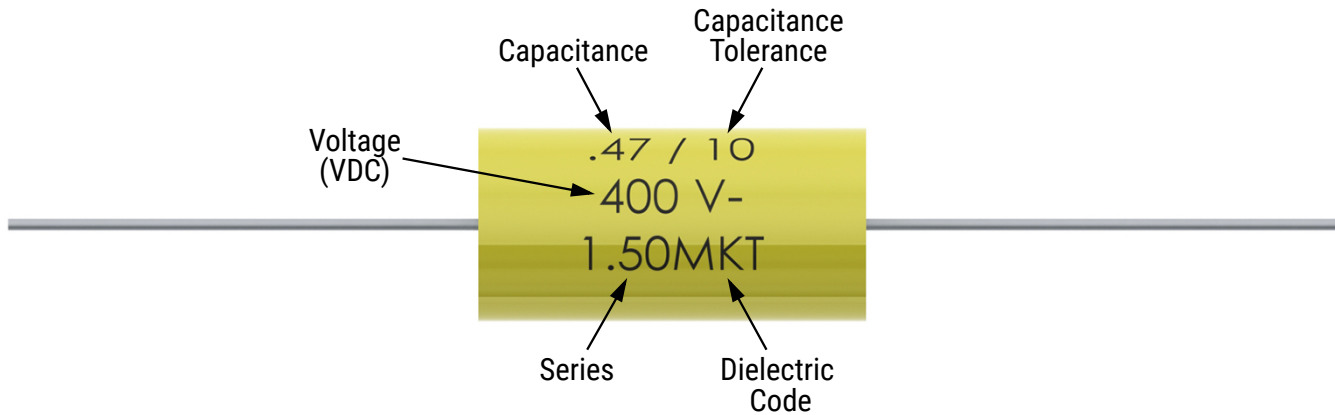

Packaging Quantities

Diameter (mm)	Length (mm)	Bulk Long Leads	Standard Reel 355 mm
5	11	1,500	3,000
6.5	11	1,200	1,300
5	14	2,000	1,300
5.5	14	2,000	1,300
6	14	2,000	1,300
6.5	14	2,000	1,200
7	14	1,750	1,100
7.5	14	1,500	1,000
8	14	1,250	900
6	20.5	1,500	1,300
6.5	20.5	1,250	1,200
7	20.5	1,250	1,100
7.5	20.5	1,000	1,000
8	20.5	1,000	900
8.5	20.5	750	800
9	20.5	750	800
9.5	20.5	750	600
10	20.5	750	600
12	20.5	500	400
7	28	750	1,000
8	28	500	900
8.5	28	500	800

Diameter (mm)	Length (mm)	Bulk Long Leads	Standard Reel 355 mm
9	28	500	800
9.5	28	500	600
10	28	500	600
10.5	28	500	400
11	28	500	400
12.5	28	300	400
10	33	400	400
10.5	33	400	400
11	33	400	400
11.5	33	400	400
12	33	300	400
12.5	33	300	400
13	33	300	400
13.5	33	300	300
14.5	33	300	300
15	33	300	300
15.5	33	200	250
16	33	200	250
17.5	33	200	200
18.5	33	150	150
19	33	150	150
22	33	100	-

Lead Taping & Packaging (IEC 60286-1)



Taping Specification

Description	Symbol	Dimensions (mm)
Component diameter	D	4.5 – 19.5
Body length	L	11 – 33
Component lead spacing	A ⁽¹⁾	See Table 2
Reel core diameter	E	85
Arbor hole diameter	M	30
Reel diameter	Ø	355 maximum
Tape width	H	6 ±0.5/9 ±1 ⁽²⁾
Body location (lateral deviation)	G	≤ 0.7
Body location (longitudinal deviation)	N	≤ 1.2
Tape spacing	B	See Table 3
Lead length from the component body to the adhesive tape	I	≥ 20
Distance between reel flanges	C	See Table 3

(1) Maximum cumulative feed hole error; 1.5 mm per 6 parts.

(2) 9±1 for capacitor with L ≥ 31.5.

Table 2

Dimensions in mm	
Diameter	A
≤ 5	5±0.5
5.1 – 9.5	10±0.5
9.6 – 14.7	15±0.5
14.8 – 19.5	20±1.0

Table 3

Dimensions in mm			
Length	Class	B ^{±1.5}	C
≤ 11	I	52.4	75
14 – 20.5	II	63.6	86
≥ 26	III	73.0	98

KEMET Electronics Corporation Sales Offices

For a complete list of our global sales offices, please visit www.kemet.com/sales.

Disclaimer

YAGEO Corporation and its affiliates do not recommend the use of commercial or automotive grade products for high reliability applications or manned space flight.

All product specifications, statements, information and data (collectively, the "Information") in this datasheet are subject to change. The customer is responsible for checking and verifying the extent to which the Information contained in this publication is applicable to an order at the time the order is placed. All Information given herein is believed to be accurate and reliable, but it is presented without guarantee, warranty, or responsibility of any kind, expressed or implied.

Statements of suitability for certain applications are based on KEMET Electronics Corporation's ("KEMET") knowledge of typical operating conditions for such applications, but are not intended to constitute – and KEMET specifically disclaims – any warranty concerning suitability for a specific customer application or use. The Information is intended for use only by customers who have the requisite experience and capability to determine the correct products for their application. Any technical advice inferred from this Information or otherwise provided by KEMET with reference to the use of KEMET's products is given gratis, and KEMET assumes no obligation or liability for the advice given or results obtained.

Although KEMET designs and manufactures its products to the most stringent quality and safety standards, given the current state of the art, isolated component failures may still occur. Accordingly, customer applications which require a high degree of reliability or safety should employ suitable designs or other safeguards (such as installation of protective circuitry or redundancies) in order to ensure that the failure of an electrical component does not result in a risk of personal injury or property damage.

Although all product-related warnings, cautions and notes must be observed, the customer should not assume that all safety measures are indicated or that other measures may not be required.

Additional information about production site flexibility can be found [here](#)

KEMET is a registered trademark of KEMET Electronics Corporation.